

# RTG CRANE LIGHTING

Industrial Applications



LED | LIGHTING CATALOG



# ENGINEERED LIGHTING SOLUTIONS

**Vision X lighting** fixtures are not merely lighting systems, they are engineered lighting solutions. They provide increased efficiency, increased safety, decreased environmental impact, and decreased costs. Vision X LED lights offer a large increase in energy efficiency over older technologies while also increasing the safety and productivity of the working environment by outputting 80% more light than the fixtures used previously.

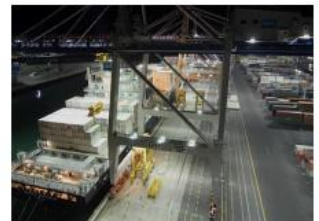



# SOLUTION PROCESS

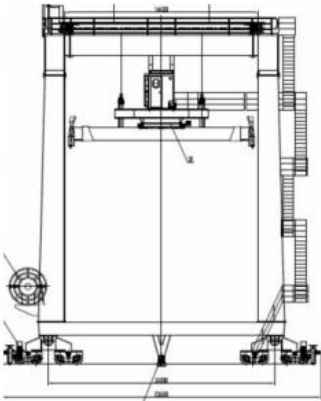

## 2D BLUEPRINT

Vision X Lighting begins each project with a customer provided list of machines to be retrofitted, then gathers the technical information for those machines.



## 3D MODEL

A 3D model is built to the customer's specifications, then carried over into the rendering.

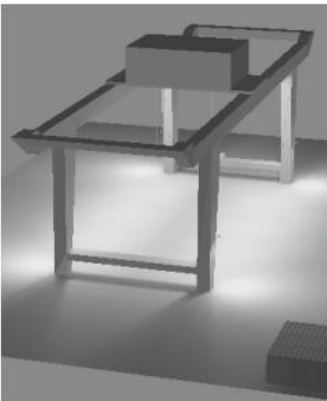

## SIMULATION RENDER

A simulation rendering ensures the final product will meet the customer's lighting requirements.

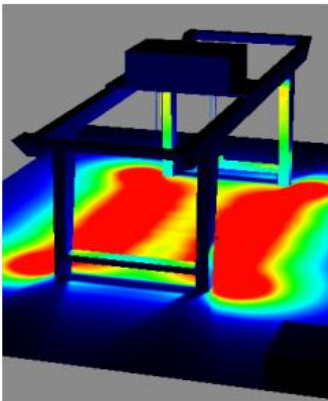

## SOLUTION

Vision X Lighting creates a complete breakdown of the customer's specific needs to meet their safety requirements.



# RTG CRANE LIGHTING FITOUT GUIDE



## GIRDER LIGHTING AC-SERIES GANTRY LIGHT

Number of Fixtures : 2  
Mounting Locations : **Under Cabin, Outside Top Girders**  
Beam Pattern : **40°, 60°**  
Part # : **LSG0660xxGANHV**

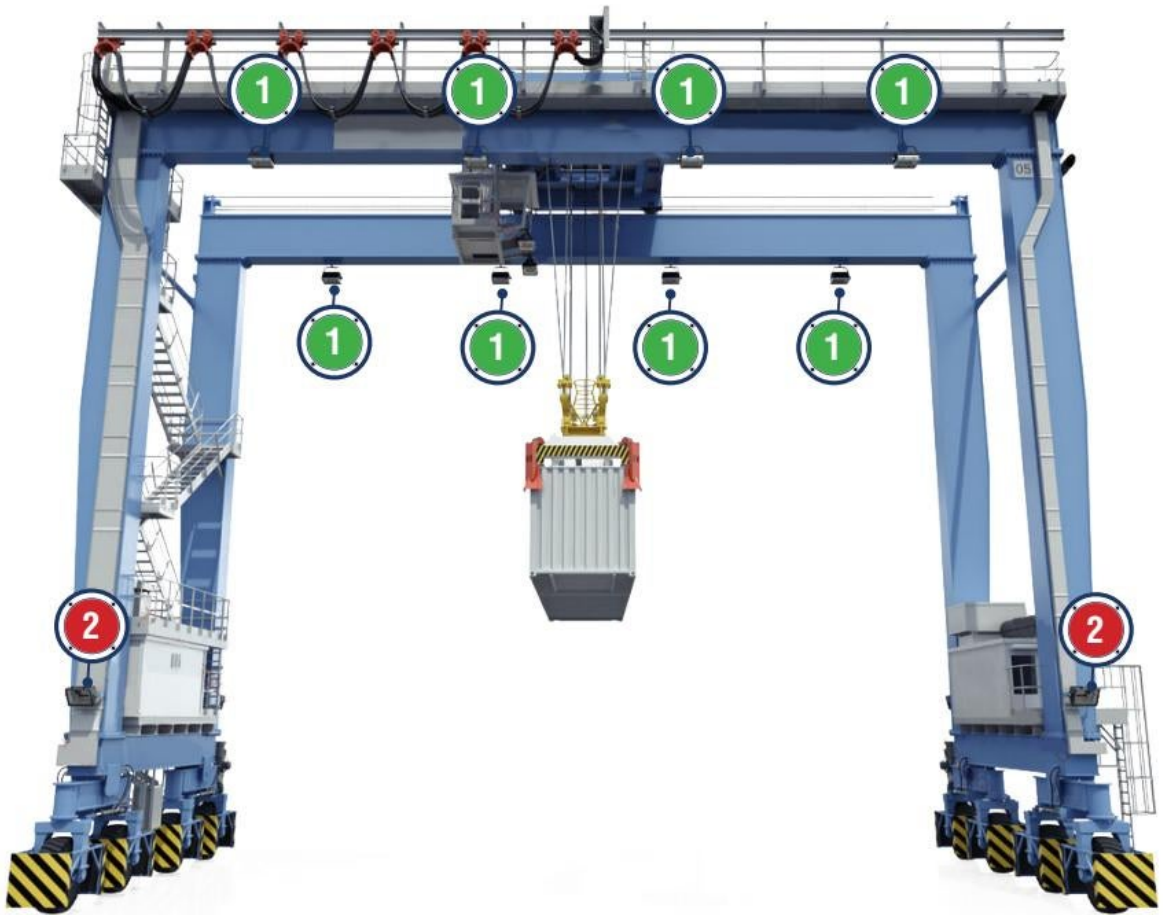

2

AC 140W



WORK AREA LIGHTING  
**AC-SERIES GANTRY LIGHT**

Number of Fixtures : 4  
Mounting Locations : **Outer Legs**  
Beam Pattern : **60°, 90°**  
Part # : **LSG0630xxGANHV**



# GIRDER LIGHTING

## Product Information

Project Name:  
Date:  
Type:

### Application

Designed to outshine and outlast the competition, the AC Girder Lighting fixture features advanced electronic technology like Pulse Width Modulation, Electronic Thermal Management, and a Redundant Circuit Design (60 LED) that allow the fixture to function even if half of the light should fail in extreme conditions. This is part of the effort by Vision X to ensure that the AC Girder Lighting fixture is the most dependable LED fixture in the workplace.

## SPECIFICATIONS

### Mechanical Information:

Fixture Weight:	37.05 lbs (16.81kg)
Shipping Weight:	40.05 lbs (18.17kg)
Mounting/ Entries: (See Accessories)	(1) 3/4" NPT - TOP (2) 3/4" NPT 90° - SIDES (2) 3/4" NPT 45° - SIDES

### Electric Specifications:

Operating Voltage:	90 - 305V AC 127 - 431V DC
Lumens:	36000 - 42000 lm
Wattage:	280W
Operating Temp:	-40°C ~ 60°C
THD:	<20% (@load≥50% / 115VAC,230VAC) (@load≥75% / 277VAC)
Power Factor:	≥ 0.98/115VAC ≥ 0.95/230VAC ≥ 0.92/277VAC
Short Circuit:	Constant Current Limiting, Recovers Automatically After Fault Condition is Removed
Frequency:	47-63Hz
Vibration:	15.6Grms

### Construction:

Housing:	Die-Cast 6061 Aluminum
Finish:	Gloss Grey
Lens:	Polycarbonate Lens

### LED Light Engine / Driver

LED:	XP-LHD(CREE)
Amp Draw:	2.43A @ 115VAC 1.22A @ 230VAC 1.01A @ 277VAC
Lifespan:	50,000 hr



### PART #:

### BEAM PATTERN

1 LSG066040GANHV	40° Medium
LSG066060GANHV	60° Flood

### 2D DRAWING:

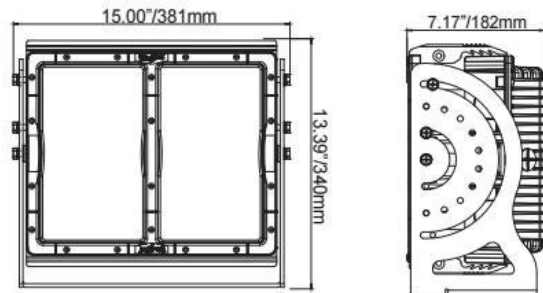

### RATINGS:

EMC Emission:	Compliance to EN55015, EN55022 (CISPR22) Class B, EN61000-3-2 Class C (@Load ≥ 50%); EN61000-3-3
EMC Immunity:	Compliance to EN61000-4-2,3,4,5,6,8,11, EN61547, EN55024, Light Industry Level (surge immunity Line-Earth 4KV, Line-Line 2KV)
UL 1598A Marine:	✓
Ingress Protection:	IP-68, IP69k





# GIRDER LIGHTING

## Ordering Information

Project Name:  
Date:  
Type:

### ORDERING NUMBER LOGIC

Ordering Example: LUC-60-18K-280-SD-LV-GR-5K

LUC	60	36K	280	SD	LV	GR	5K	---
Series	# of LED's	Lumens	Watts	Beam Pattern	Voltage	Housing Color	Color Temp.	Accessories
<b>SERIES</b>		<b>Lumens</b>		<b>Beam Pattern</b>		<b>Housing Color</b>		
LUC	Lucent Engineering	36K	36,000 Lumens	SD	Spot 10°	GR	Grey Housing	
<b>NUMBER OF LED'S</b>		42K	42,000 Lumens <small>*only avail. in UD beam*</small>	ND	Narrow 25°	<b>Color Temperature</b>		
60	60 High Output LEDs	<b>Watts</b>		MD	Medium 40°	5K	5,000° Kelvin	
140	140 High Output LEDs	280	Total Fixture Watts	FD	Flood 60°			
				WD	Wide Flood 90°			
				UD	Ultra Wide Flood 180° <small>*only avail. in 42K lumens*</small>			
				<b>Voltage</b>				
				LV	Low Voltage 90-277vAC			
				HV	High Voltage 480vAC			

### ACCESSORIES

TR	Trunnion Bracket
TRHD	Trunnion Bracket Heavy Duty
STRHD	Trunnion Bracket Heavy Duty Stainless Steel
CHM2	2" ID Cobra Head Slipfitter Mount
CHM2.5	2.5" ID Cobra Head Slipfitter Mount
CHM3	3" ID Cobra Head Slipfitter Mount
PM	Pedant Mount Hook
SW34	3/4" Adjustable Swivel
S2	2" ID Universal Slipfitter Mount
S2.5	2.5" ID Universal Slipfitter Mount
S3	3" ID Universal Slipfitter Mount
OCY	Occupancy Sensor
DTD	Dusk to Dawn Sensor
YTL	277VAC Twist Lock Plug 6.6'/2M Whip Yellow
YSL	277VAC Twist Lock Plug 6.6'/2M Whip Black
BTL	120VAC Plug 6.6'/2M Whip Yellow
BSL	120VAC Plug 6.6'/2M Whip Black
PC2M	3P Female Quick Connect 2M
YBC1M	Bulk Cable Yellow PVC Jacket 3x16 AWG Conductors
BBC1M	Bulk Cable Black PVC Jacket 3x16 AWG Conductors





# GIRDER LIGHTING

## Photometric Data

Project Name:  
Date:  
Type:

### PHOTOMETRIC DATA: Maximum Intensity (cd)

#### Spot 10°

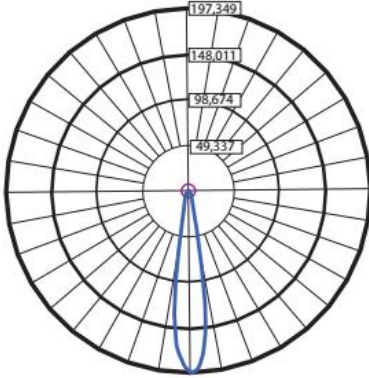

#### Narrow 25°

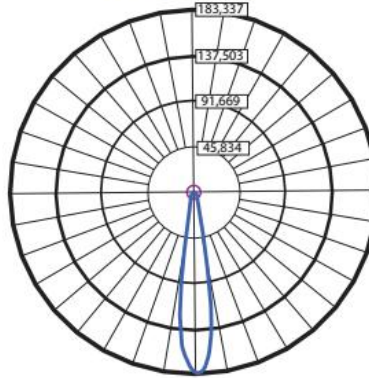

#### Medium 40°

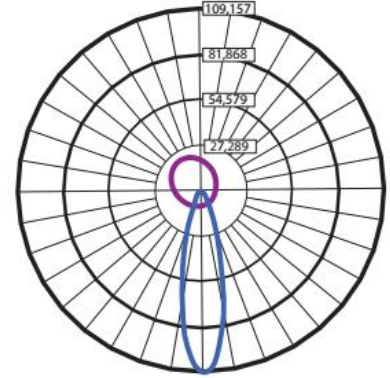

#### Elliptical 30/60°

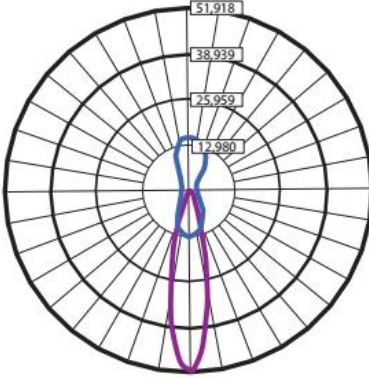

#### Flood 60°

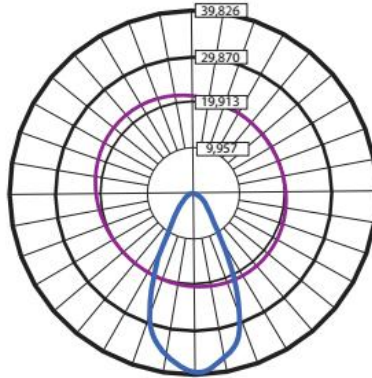

#### Wide Flood 90°

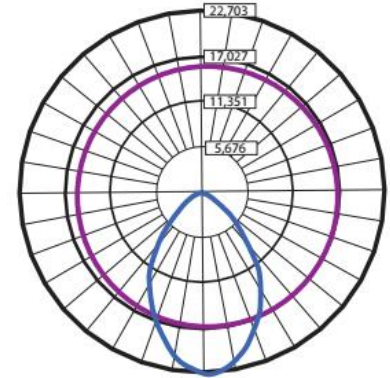





# GIRDER LIGHTING Accessories

Project Name:  
Date:  
Type:

## TRUNNION BRACKETS:

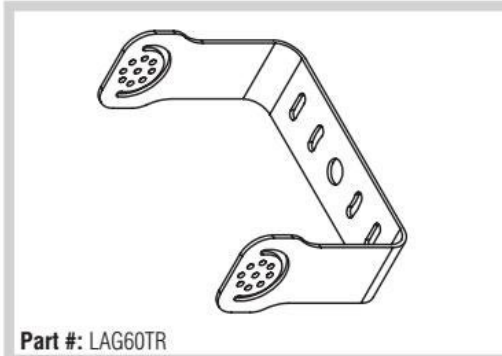

### Dimensions:

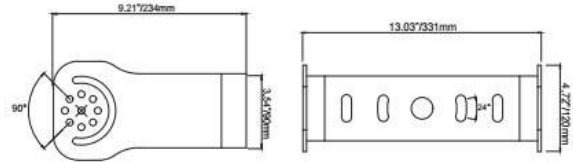

Part #: LAG60TR

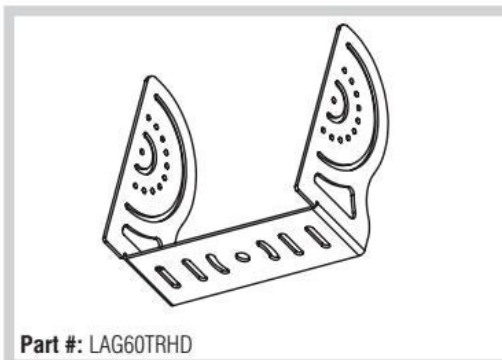

### Dimensions:

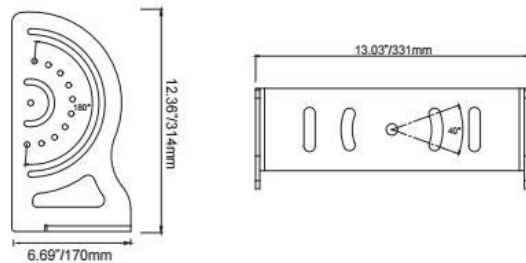

Part #: LAG60TRHD

## ACCESSORY HARDWARE:



**10' QUICK CONNECT WIRE**  
Part# : LAYUBC1M



**3/4" JUNCTION BOX QUICK CONNECT**  
Part# : LASUQC34



**110V AC PLUG**  
Part# : LAYSL



**240-277V AC TWIST LOCK PLUG**  
Part# : LAYTL



**PENDANT MOUNT HOOK**  
Part# : LAGPM



**DUSK/DAWN SENSOR**  
Part# : LAGDTD



**3/4" ADJUSTABLE SWIVEL**  
Part# : LAGSW34



**SLIP FITTING**  
Part# :  
2" Diameter : LAGUS2  
2.5" Diameter : LAGUS2.5  
3" Diameter : LAGUS3



# WORK AREA LIGHTING

## Product Information

Project Name:  
Date:  
Type:

### Application

Designed to outshine and outlast the competition, the AC Work Area fixture features advanced electronic technology like Pulse Width Modulation, Electronic Thermal Management, and a Redundant Circuit Design (30 LED) that allow the fixture to function even if half of the light should fail for unknown reasons. This is part of the effort by Vision X to ensure that the AC Work Area fixture is the most dependable LED fixture in the workplace.

### SPECIFICATIONS

#### Mechanical Information:

<b>Fixture Weight:</b>	22.05 lbs (10kg)
<b>Shipping Weight:</b>	26.9 lbs (12.2kg)
<b>Mounting/ Entries: (See Accessories)</b>	(1) 3/4" NPT - TOP (2) 3/4" NPT 90° - SIDES (2) 3/4" NPT 45° - SIDES

#### Electric Specifications:

<b>Operating Voltage:</b>	90 - 305V AC 127 - 431V DC
<b>Lumens:</b>	18000 - 21000 lm
<b>Wattage:</b>	140W
<b>Operating Temp:</b>	-40°C ~ 60°C
<b>THD:</b>	<20% (@load≥50% / 115VAC,230VAC) (@load≥75% / 277VAC)
<b>Power Factor:</b>	≥ 0.98/115VAC ≥ 0.95/230VAC ≥ 0.92/277VAC
<b>Short Circuit:</b>	Constant Current Limiting, Recovers Automatically After Fault Condition is Removed
<b>Frequency:</b>	47-63Hz
<b>Vibration:</b>	15.6Grms

#### Construction:

<b>Housing:</b>	Die-Cast 6061 Aluminum
<b>Finish:</b>	Gloss Grey
<b>Lens:</b>	Polycarbonate Lens

#### LED Light Engine / Driver

<b>LED:</b>	XP-L(CREE)
<b>Amp Draw:</b>	1.22A @ 115VAC 0.61A @ 230VAC 0.51A @ 277VAC
<b>Lifespan:</b>	50,000 hr



#### PART #: BEAM PATTERN

<b>2</b> LSG063060GANHV	60° Flood
LSG063090GANHV	90° Wide Flood

#### 2D DRAWING:

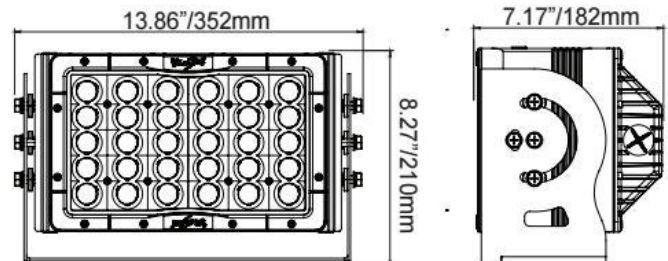

#### RATINGS:

<b>EMC Emission:</b>	Compliance to EN55015, EN55022 (CISPR22) Class B, EN61000-3-2 Class C (@Load ≥ 50%); EN61000-3-3
<b>EMC Immunity:</b>	Compliance to EN61000-4-2,3,4,5,6,8,11, EN61547, EN55024, Light Industry Level (surge immunity Line-Earth 4KV, Line-Line 2KV)
<b>UL 1598A Marine:</b>	
<b>Ingress Protection:</b>	IP-68, IP69k





# WORK AREA LIGHTING

## Ordering Information / Photometric Report

Project Name:  
Date:  
Type:

### ORDERING NUMBER LOGIC

Ordering Example: LUC-30-18K-140-SD-LV-GR-5K

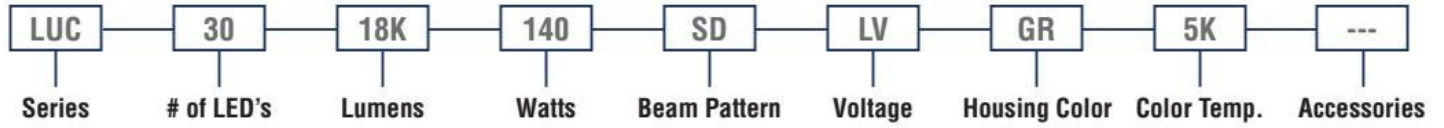

SERIES		Lumens		Beam Pattern		Housing Color	
LUC	Lucent Engineering	18K	18,000 Lumens	SD	Spot 10°	GR	Grey Housing
<b>NUMBER OF LEDS</b>		21K	21,000 Lumens <small>*only avail. in UD beam*</small>	ND	Narrow 25°	<b>Color Temperature</b>	
30	30 High Output LEDs	<b>Watts</b>		MD	Medium 40°	5K	5,000° Kelvin
70	70 High Output LEDs	140	Total Fixture Watts	FD	Flood 60°		
				WD	Wide Flood 90°		
				UD	Ultra Wide Flood 180° <small>*only avail. in 21K Lumens*</small>		
				<b>Voltage</b>			
				LV	Low Voltage 90-277vAC		
				HV	High Voltage 480vAC		

### ACCESSORIES

TR	Trunnion Bracket
TRHD	Trunnion Bracket Heavy Duty
STRHD	Trunnion Bracket Heavy Duty Stainless Steel
CHM2	2" ID Cobra Head Slipfitter Mount
CHM2.5	2.5" ID Cobra Head Slipfitter Mount
CHM3	3" ID Cobra Head Slipfitter Mount
PM	Pendant Mount Hook
SW34	3/4" Adjustable Swivel
S2	2" ID Universal Slipfitter Mount
S2.5	2.5" ID Universal Slipfitter Mount
S3	3" ID Universal Slipfitter Mount
OCY	Occupancy Sensor
DTD	Dusk to Dawn Sensor
YTL	277VAC Twist Lock Plug 6.6'/2M Whip Yellow
YSL	277VAC Twist Lock Plug 6.6'/2M Whip Black
BTL	120VAC Plug 6.6'/2M Whip Yellow
BSL	120VAC Plug 6.6'/2M Whip Black
PC2M	3P Female Quick Connect 2M
YBC1M	Bulk Cable Yellow PVC Jacket 3x16 AWG Conductors
BBC1M	Bulk Cable Black PVC Jacket 3x16 AWG Conductors



# WORK AREA LIGHTING

## Photometric Data

Project Name:  
Date:  
Type:

### PHOTOMETRIC DATA: Maximum Intensity (cd)

#### Spot 10°

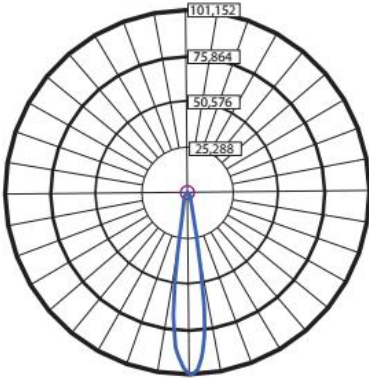

#### Narrow 25°

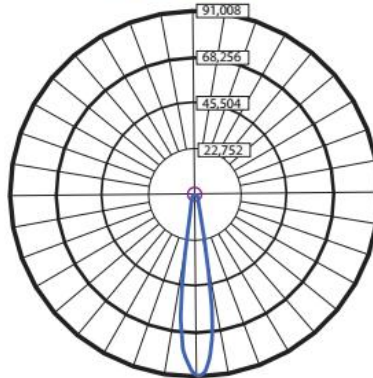

#### Medium 40°

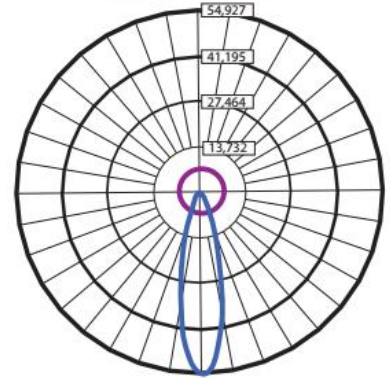

#### Elliptical 30/60°

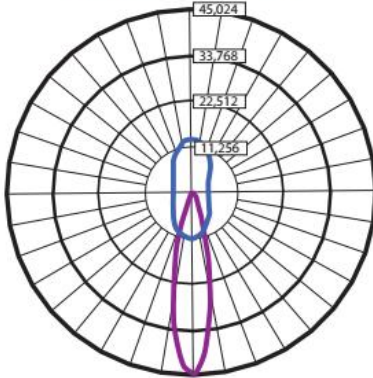

#### Flood 60°

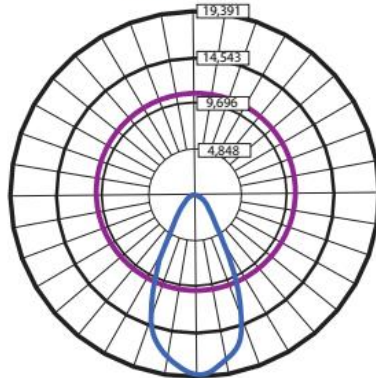

#### Wide Flood 90°

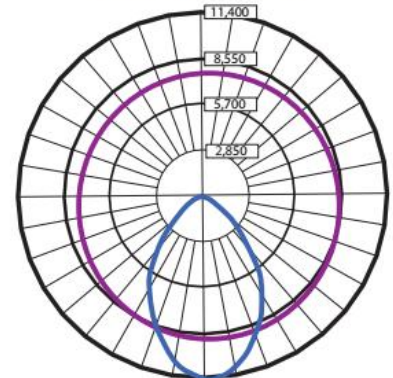



# WORK AREA LIGHTING Accessories

Project Name:  
Date:  
Type:

## TRUNNION BRACKETS:



### Dimensions:

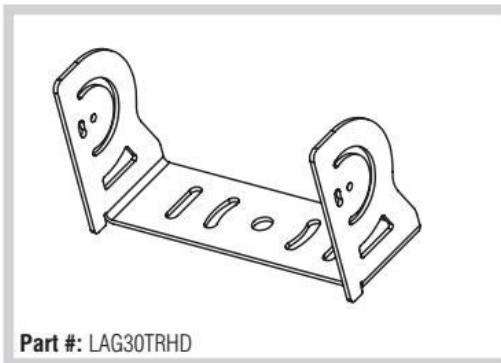
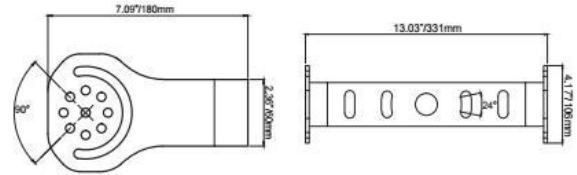

### Dimensions:

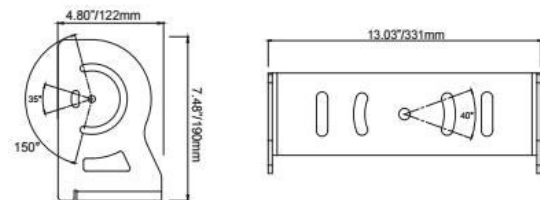

## ACCESSORY HARDWARE:



**10' QUICK CONNECT WIRE**  
**Part# :** LAYUBC1M



**3/4" JUNCTION BOX QUICK CONNECT**  
**Part# :** LASUQC34



**110V AC PLUG**  
**Part# :** LAYSL



**240-277V AC TWIST LOCK PLUG**  
**Part# :** LAYTL



**PENDANT MOUNT HOOK**  
**Part# :** LAGPM



**DUSK/DAWN SENSOR**  
**Part# :** LAGDTD



**3/4" ADJUSTABLE SWIVEL**  
**Part# :** LAGSW34



**SLIP FITTING**  
**Part# :**  
**2" Diameter :** LAGUS2  
**2.5" Diameter :** LAGUS2.5  
**3" Diameter :** LAGUS3







Copyright © 2019 Vision X Lighting Revised: 4/5/19

 **APS**  
LIGHTING & SAFETY  
www.aps-supply.com

**APS USA**  
610 Gateway Center Way, Suites J & K  
San Diego, CA 92102 USA  
P: 1 619 263 4164  
F: 1 619 263 6814

**APS Australia**  
U48 / 9 Vision Street,  
Wangara, WA 6065 Australia  
Phone: 61 (8) 9302 2369  
Fax: 61 (8) 6305 0047

**APS: Singapore**  
**Mexico**  
**Colombia**  
**Chile**  
**Perú**