



NOTE

All numerical values are in metric units [with U.S. customary units in brackets]. Dimensions are in millimeters [and inches]. Unless otherwise specified, dimensions have a tolerance of ± 0.13 [$\pm .005$] and angles have a tolerance of $\pm 2^\circ$. Figures and illustrations are for identification only and are not drawn to scale.

1. INTRODUCTION

This specification covers the requirements for application of DEUTSCH DT series connector system. The system features a plug and receptacle that offers 2, 3, 4, 6, 8, and 12-pin arrangements which accept DEUTSCH size 16 solid (machined) or stamped & formed contacts.

The plug and receptacle each consist of a housing and secondary wedge lock. The secondary wedge lock is used to ensure that the contact is fully seated and secure in the connector. The connector and the secondary wedge lock are shipped separately. These connectors feature integral latch-style mating. The 8 & 12 pin arrangements feature integral keying and are color-coded.

Basic terms and features of this product are provided below. Pages 2 through 5 provide examples of additional features and modifications. 4 & 12 pin shown as example

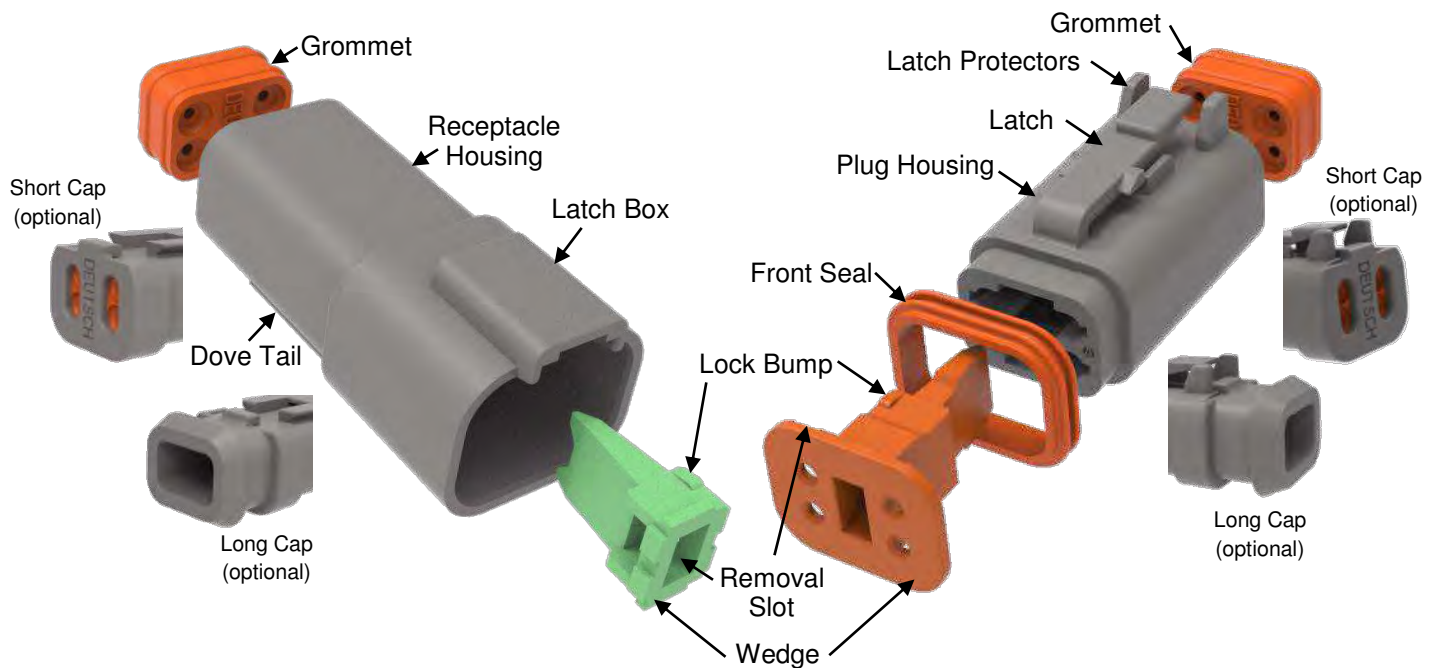

Standard Features All Arrangements
(4-pin example)

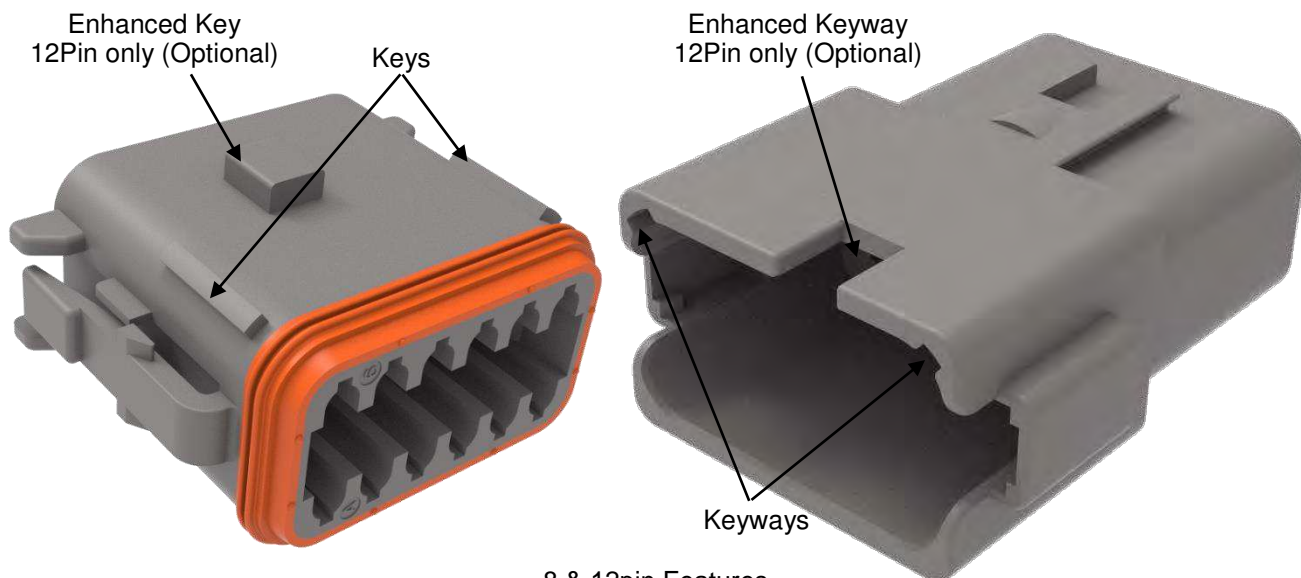

8 & 12pin Features
(12-pin example)



A Key
(Grey)



B Key
(Black)

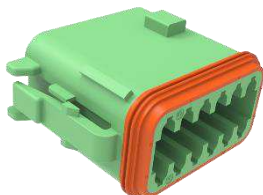

C Key
(Green)

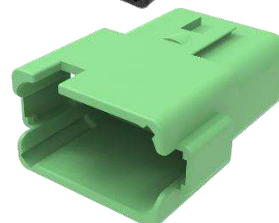

D Key
(Brown)



1.1. Receptacle

2 to 6-pin



*8 and 12-pin
A key*



Receptacles, No Cap
Gray and Black

2 to 6-pin



*8 and 12-pin
A key*

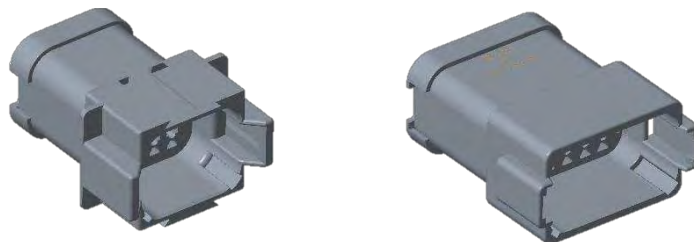

Receptacles, Short Cap
Gray and Black

1.1 Receptacle (Con't)

2 to 6-pin



8 and 12-pin
A key

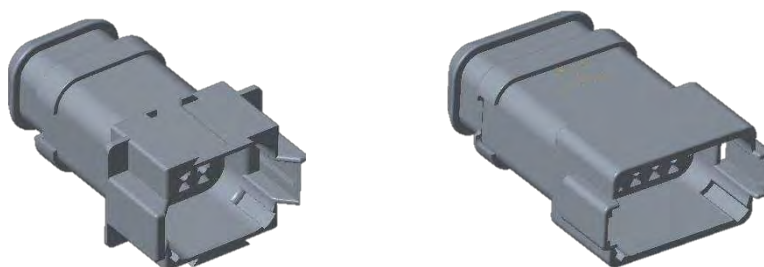

Receptacles, Long Cap
Gray and Black

2 to 6-pin

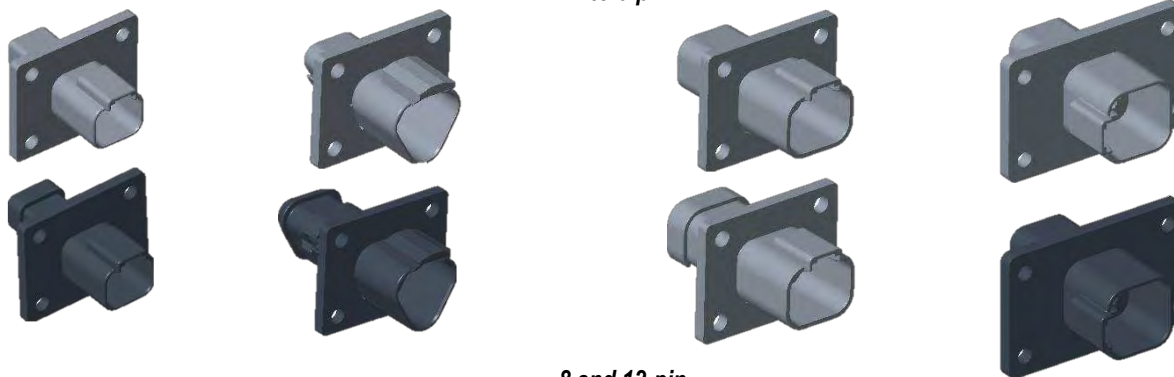

8 and 12-pin
A key

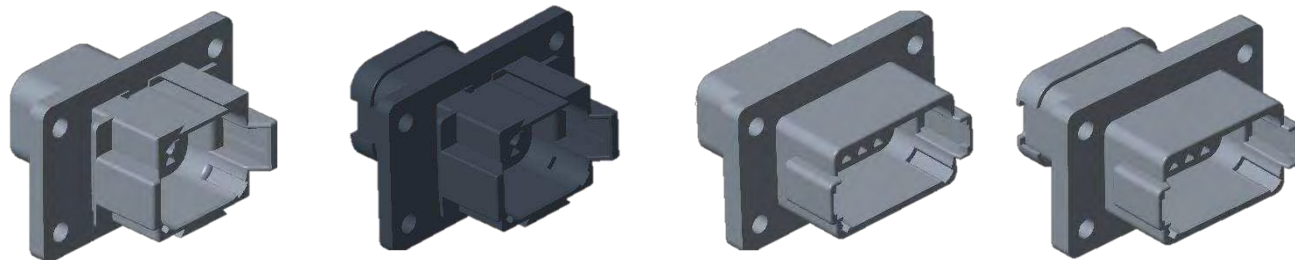

Receptacles, Flange, No Cap, Standard Cap,
Gray and Black

1.2. Plug

2 to 6-pin



8 and 12-pin
A key



Plug, Standard Seal, No Cap, Gray
Seal Retention, No Cap, Black

2 to 6-pin



8 and 12-pin
A key



Plug, Standard Seal, Short Cap, Gray
Seal Retention, Short Cap, Black

1.2. Plug (Con't)

2 to 6-pin



8 and 12-pin
A key



Plug, Standard Seal, Long Cap, Gray
Seal Retention, Long Cap, Black

1.3. Plug & Wedge Lock Comparison (Standard Vs Seal Retention)

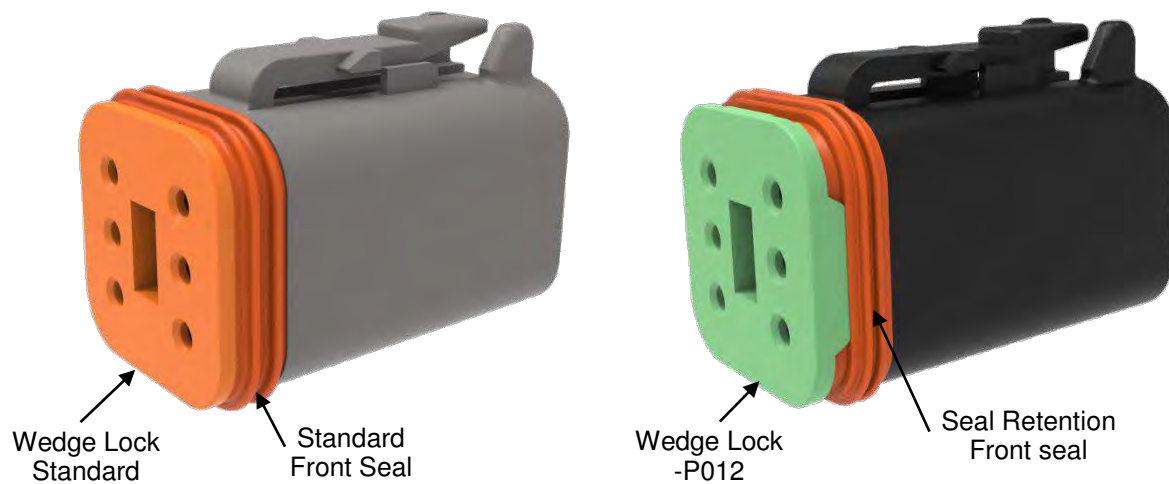

i NOTE
Do not use -P012 wedgelock with standard front seal.



1.4. Plug Front Seal Replacement

Front seal must be present and properly seated prior to use. If the front seal has fallen off during transportation, locate it in the box and re-install the seal, as shown below. If the seal cannot be located, please contact TE for replacement seals.

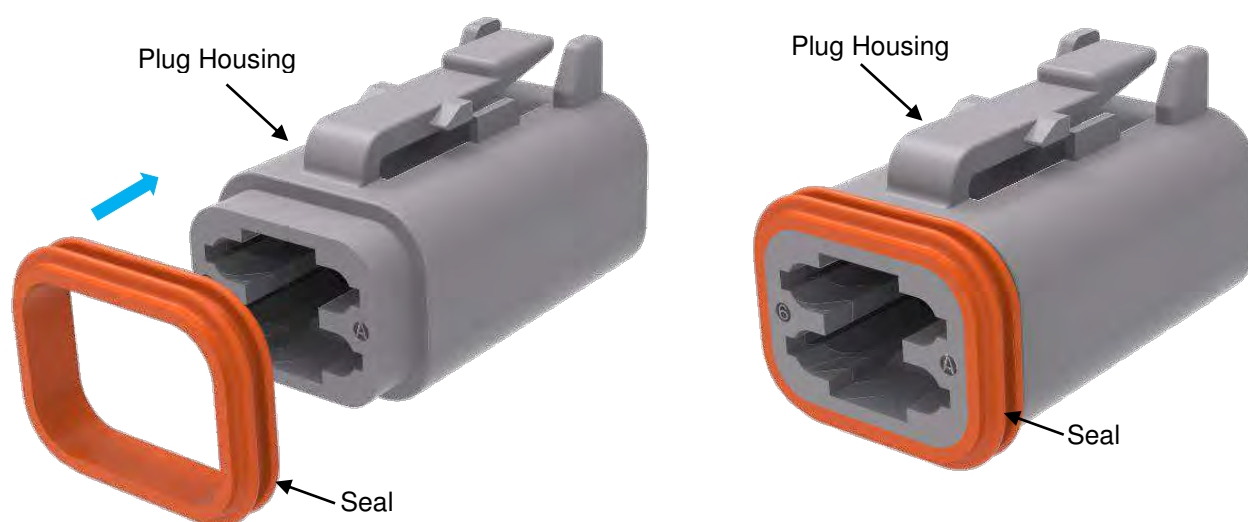

1.5 Product Dimensions

See connector and wedge product drawing for product dimensions. See section 2.3

2. REFERENCE MATERIAL

2.1. Revision Summary

See section 8

2.2. Customer Assistance

Reference Product Base Part Numbers DT04-2P, DT04-3P, DT04-4P, DT04-6P, DT04-08PX, DT04-12PX (receptacles), and DT06-2S, DT06-3S, DT06-4S, DT06-6S, DT06-08SX, DT06-12SX (plugs) (X = A to D keys) and Product Code EQ59 are representative of DEUTSCH DT series connector system. Use of these numbers will identify the product line and help you to obtain product and tooling information when visiting www.te.com or calling the number at the bottom of page 1.

2.3. Drawings

Customer drawings for product part numbers are available from www.te.com. Information contained in the customer drawing takes priority. X refers to A, B, C, D keys; XXXX refers to product modification.

CONNECTORS

Product Drawing	Description	Product Drawing	Description
DT04-2P-XXXX	2 Pin Receptacle	DT06-2S-XXXX	2 Pin Plug
DT04-3P-XXXX	3 Pin Receptacle	DT06-3S-XXXX	3 Pin Plug
DT04-4P-XXXX	4 Pin Receptacle	DT06-4S-XXXX	4 Pin Plug
DT04-6P-XXXX	6 Pin Receptacle	DT06-6S-XXXX	6 Pin Plug
DT04-08PX-XXXX	8 Pin Receptacle	DT06-08SX-XXXX	8 Pin Plug
DT04-12PX-XXXX	12 Pin Receptacle	DT06-12SX-XXXX	12 Pin Plug

WEDGE

Product Drawing	Description	Product Drawing	Description
W2PX-XXXX	2 pin Rcpt Wedge Lock	W2SX-XXXX	2 pin Plug Wedge Lock
W3P-XXXX	3 pin Rcpt Wedge Lock	W3S-XXXX	3 pin Plug Wedge Lock
W4PX-XXXX	4 pin Rcpt Wedge Lock	W4SX-XXXX	4 pin Plug Wedge Lock
W6PX-XXXX	6 pin Rcpt Wedge Lock	W6SX-XXXX	6 pin Plug Wedge Lock
W8P-XXXX	8 pin Rcpt Wedge Lock	W8S-XXXX	8 pin Plug Wedge Lock
W12P-XXXX	12 pin Rcpt Wedge Lock	W12S-XXXX	12 pin Plug Wedge Lock



Note:
X = A,B,C, D Key
XXXX = Modification. See section 3.3H

2.4. Specifications

- [108-151009](#) DT Series Product Specification
- [114-151000](#) Application Specification for DEUTSCH Size 16 S&F Pin & Socket
- [114-151001](#) Application Specification for DEUTSCH Size 16 S&F Pin & Socket
- [114-151004](#) Application Specification for DEUTSCH Size 4-20 Solid Pin & Socket
- [408-151008](#) Removal Tool DT-RT1 for Front-Release Connectors
- [108-151000](#) DEUTSCH S&F Contacts
- [108-151004](#) DEUTSCH Solid Contacts

2.5. Instructional Material

Instruction sheets (408-series) provide product assembly instructions or tooling setup, and operation procedures and customer manuals (409-series) provide machine setup and operating procedures. Instructional material that pertain to this product are:

[408-151008](#) DEUTSCH Removal Tool DT-RT1 for Front-Release Connectors

3. REQUIREMENTS

3.1. Safety

Do not stack product shipping containers so high that the containers buckle or deform.

3.2. Storage

A. Ultraviolet Light

Prolonged exposure to ultraviolet light may deteriorate the chemical composition used in the product material.

B. Shelf Life

The product should remain in the shipping containers until ready for use to prevent deformation to components. The product should be used on a first in, first out basis to avoid storage deterioration could adversely affect performance.

C. Chemical Exposure

Do not store product near any chemical listed below as they may cause stress corrosion cracking in the material.

Alkalis	Ammonia	Citrates	Phosphates	Sulfur Compounds	
Acids	Amines	Carbonates	Nitrites	Sulfur Nitrites	Tartrates



NOTE

Resistance depends on chemical concentration, temperature, and exposure medium.

3.3. Characteristics

A. Part Numbering System

CONNECTOR

Part Number
DT06 - 2 S X - XXXX

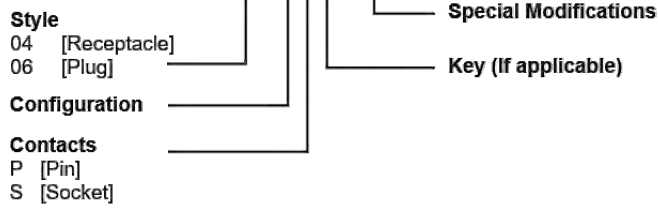

WEDGE

Part Number
W2 S X - XXXX



i Note:
Pins used in receptacle Sockets used in plug

B. Pin Arrangement

See product drawing for contact cavity marking

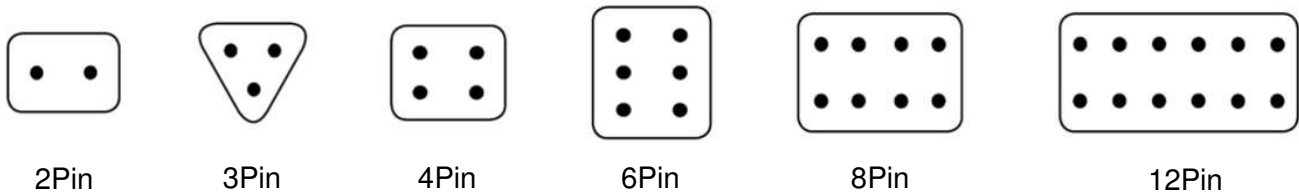







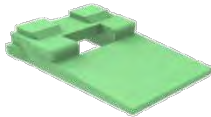
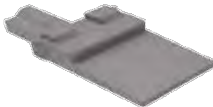
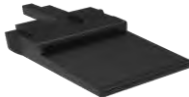
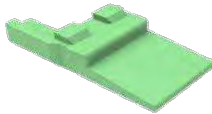

C. Materials

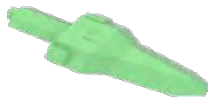
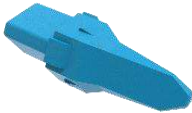
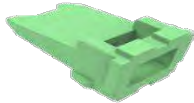
- Receptacle and Plug Housings: PA66 GF15 (gray, black, green, or brown)
- Caps: PA66 GF15 (gray, black, green, or brown)
- Flanges: PA66 GF15 (gray or black)
- Wedge Locks: PBT GF30 (orange, green, blue, gray, black, brown)
- Front Seal: VMQ (red-orange)
- Grommets: VMQ (standard seal red-orange, E-seal burnt red)
- Threaded Inserts: Stainless Steel





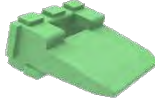

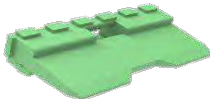
D. Wedge Locks









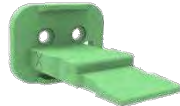

Receptacle Wedge Locks



PN	Description	Shape and Color	
W2P	Wedgeloek for 2 pin receptacle		Green
W2PA	Wedgeloek for 2 pin receptacle "A" key		Gray
W2PB	Wedgeloek for 2 pin receptacle "B" key		Black
W2PC	Wedgeloek for 2 pin receptacle "C" key		Green
W2PD	Wedgeloek for 2 pin receptacle "D" key		Brown
W3P	Wedgeloek for 3 pin receptacle		Green
W3P-1939	Wedgeloek for 3 pin receptacle "J1939" key		Blue
W4P	Wedgeloek for 4 pin receptacle		Green
W4PA	Wedgeloek for 4 pin receptacle " A " key		Gray
W4PB	Wedgeloek for 4 pin receptacle " B " key		Black
W4PC	Wedgeloek for 4 pin receptacle " C " key		Green

PN	Description	Shape and Color	
W4PD	Wedgeloock for 4 pin receptacle " D " key		Brown
W6P	Wedgeloock for 6 pin receptacle		Green
W8P	Wedgeloock for 8 pin receptacle		Green
W12P	Wedgeloock for 12 pin receptacle		Green

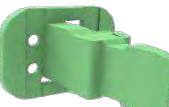
Plug Wedge Locks

PN	Description	Color and Shape	
W2S	Wedgeloock for 2 pin plug		Orange
W2SA	Wedgeloock for 2 pin plug "A" key		Gray
W2SB	Wedgeloock for 2 pin plug "B" key		Black
W2SC	Wedgeloock for 2 pin plug "C" key		Green
W2SD	Wedgeloock for 2 pin plug "D" key		Brown
W2S-P012	Wedgeloock for 2 pin plug		Green
W2SA-P012	Wedgeloock for 2 pin plug "A" key		Gray

PN	Description	Color and Shape	
W2SB-P012	Wedgeloock for 2 pin plug "B" key		Black
W2SC-P012	Wedgeloock for 2 pin plug "C" key		Green
W2SD-P012	Wedgeloock for 2 pin plug "D" key		Brown
W3S	Wedgeloock for 3 pin plug		Orange
W3S-1939	Wedgeloock for 3 pin plug "J1939" key		Blue
W3S-P012	Wedgeloock for 3 pin plug "P012"		Green
W3S-1939-P012	Wedgeloock for 3 pin plug "1939-P012" key		Blue
W4S	Wedgeloock for 4 pin plug		Orange
W4SA	Wedgeloock for 4 pin plug "A" key		Gray
W4SB	Wedgeloock for 4 pin plug "B" key		Black
W4SC	Wedgeloock for 4 pin plug "C" key		Green
W4SD	Wedgeloock for 4 pin plug "D" key		Brown





PN	Description	Color and Shape	
W4S-P012	Wedgelock for 4 pin plug "P012"		Green
W4SA-P012	Wedgelock for 4 pin plug "A" key		Gray
W4SB-P012	Wedgelock for 4 pin plug "B" key		Black
W4SC-P012	Wedgelock for 4 pin plug "C" key		Green
W4SD-P012	Wedgelock for 4 pin plug "D" key		Brown
W6S	Wedgelock for 6 pin plug		Orange
W6S-P012	Wedgelock for 6 pin plug "P012"		Green
W8S	Wedgelock for 8 pin plug		Orange
W8S-P012	Wedgelock for 8 pin plug "P012"		Green
W12S	Wedgelock for 12 pin plug		Orange
W12S-P012	Wedgelock for 12 pin plug "P012"		Green

E. Sealing Range

Conductor Range	Insulation OD Sealing Range in [mm]	Seal Type
14-20 AWG [2.5-0.5mm ²]	.088-.145 [2.23-3.68]	N-Seal
	.053-.120 [1.35-3.05]	E-Seal

F. Sealing Plugs

Open cavities provide pathways for contaminants to enter the connectors. To maintain seal integrity, any unused cavity must be filled with the appropriate size sealing plug.

Part Number	Material	Color	Description	Sealing Plug
114017	PBT	White	N-Seal E-Seal	
0413-217-1605	PBT	White	Locking N-Seal E-Seal	
0413-204-2005	PBT	Red	E-Seal only	
776363-1	PBT	Yellow	N-Seal	
776364-1	PBT	White	E-Seal	

G. Keying Pins

Keying pins are solid plastic rods used to prevent mis-mating of like connectors in close proximity. Keying pins are inserted into the retention fingers of an empty socket cavity. Once installed, the keying pin blocks a mating contact pin from being inserted. The contact pin will be blocked before the latch device mates the connectors, helping to prevent the mis-mating of like connectors. Proper usage requires that the corresponding mating pin be omitted and a sealing plug be inserted in the rear cavity of the mating connector. Individual applications will vary, and testing should be done to determine the best arrangement to help prevent improper connector mating. Multiple keying pins may be required to help prevent unintentional forced mating.

Part Number	Material	Color	Description	Sealing Plug
0413-215-1605	PBT	White	Locking N-Seal E-Seal	

i Note:
Multiple keying pins may be required to help prevent unintentional forced mating.

H. Modification











i Note:
Modifications include, but are not limited to, the following list.
Modifications listed are for reference only and may not be available for every arrangement.







Mod	Description
B016	Receptacle has extended shell and enhanced keys, plug has seal retention (P012), 12-Pin
B031	Blind Blocked Plug
BE02	Receptacle with extended shell and enhanced keys (B016), Short Cap
BE03	Receptacle with extended shell and enhanced keys (B016), Short Cap, black
BE04	Receptacle with extended shell and enhanced keys (B016), Short Cap, E- seal, black
BE05	Receptacle with extended shell and enhanced keys (B016), Short Cap, sealed flange, E-seal, Threaded Inserts
BL04	Receptacle with extended shell and enhanced keys (B016), Flange
BL08	Receptacle with extended shell and enhanced keys (B016), Flange, black
BL10	Receptacle with extended shell and enhanced keys (B016), sealed flange, E-seal, Long Cap, Threaded Inserts
BL11	Receptacle with extended shell and enhanced keys (B016), sealed flange, E-seal, Short Cap, Threaded Inserts
C015	E-seal
C017	Solid rear grommet, Short Cap
CE01	E-seal, Short Cap
CE02	E-seal, black

Mod	Description
CE03	E-seal, Short Cap, black
CE04	E-seal, Long Cap
CE05	Plug with E-seal, Seal Retention (P012), Short Cap
CE06	Plug with E-seal, Seal Retention (P012)
CE07	Receptacle with extended shell and enhanced keys (B016), Short Cap, E-seal
CE08	Receptacle with extended shell and enhanced keys (B016), E-seal
CE09	E seal, Long Cap, black
CE10	Plug with E-seal, Seal Retention (P012), black
CE11	Plug with E-seal, Seal Retention (P012), Short Cap, black
CE12	Plug with E-seal, Seal Retention (P012), Long Cap, black
CE13	Plug with E-seal, Seal Retention (P012), Long Cap
CE14	Plug with E-seal, Seal Retention (P012), latch guard cap, black
CL03	E-seal, Flange
CL07	E-seal, sealed flange, Long Cap
CL08	E-seal, Flange, Short Cap, disabled latch
CL09	E-seal, sealed flange, Short Cap, black
CL15	E-seal, Flange, black
CP01	Solid rear grommet, Seal Retention (P012), Short Cap
E003	Short Cap
E004	Black housing
E005	Black, Short Cap
E008	Long Cap
EE01	Long Cap, black
EF01	Fluorosilicone front seals, Short Cap
EF02	Fluorosilicone front seals, Latch Guard Cap
EP04	Short Cap (same as E003)
EP05	Latch Guard Cap
EP06	Plug with Seal Retention (P012), Short Cap
EP07	Plug with Seal Retention (P012), black
EP08	Plug with Seal Retention (P012), Short Cap, black
EP09	Plug with Seal Retention (P012), Latch Guard Cap, black
EP11	Plug with Seal Retention (P012), Long Cap, black
EP20	Plug with seal retention (P012), Long Cap
L012	Flange
LE01	Sealed flange, inside mount, gasket, short cap
LE03	Sealed flange, outside mount, Short Cap (12-Pin), Long Cap (8-Pin)
LE05	Sealed flange, inside mount, gasket, Short Cap
LE06	Sealed flange, inside mount, gasket, Short Cap, E-seal
LE07	Flange, Short Cap
LE08	Flange, Long Cap, gray
LE09	Sealed flange, Short Cap, black
LE10	Sealed flange, inside mount, gasket, Short Cap, black

Mod	Description
LE11	Flange, Short Cap, black
LE12	Flange, Long Cap, black
LE13	Special adapter, round housing, Short Cap, black
LE14	Flange, black
LE17	Receptacle with extended shell and enhanced keys (B016), sealed flange, Short Cap, black
LE21	Receptacle with extended shell and enhanced keys (B016), sealed flange, Short Cap, E-seal, Threaded Inserts.
P004	Same as standard part without modification
P012	Plug and Wedge Lock Seal Retention. 2,3,4,6 pin plugs are black
P032	Integrated Long Cap (J1939), 3 way, black

Common Modifications

Modification	Description	Plug	Receptacle
B016	Helps prevent mis-mating. Available for the DT 12 way connectors. In addition to the four keying positions (A, B, C, or D) and color coding, the B016 enhancement gives the user both visual and tactile proof of correct mating, thus helping eliminate mis-mating opportunities during assembly. Please note the P012 plug is the required mate for the B016 receptacle to make the enhancement effective.		
C015	Has a reduced diameter (E-seal) rear grommet to provide proper sealing with smaller wire insulation		
E003	Includes a protective end cap attached to the rear of the connector. There are holes or slots in the cap to allow the contacts to be inserted. Color: grey		
E004	Changes the connector body color to black		
E005	Includes a protective end cap attached to the rear of the connector. There are holes or slots in the cap to allow the contacts to be inserted. Color: black		

Modification	Description	Plug	Receptacle
E008	Includes an extended cap to attach shrink tubing where application requirements need extra wire protection. Color: grey		
L012	Includes a simple welded-on flange onto receptacle to simplify wire routing and assembly. Other mods: • Welded flange, no cap: BL04, BL08, CL03, LE14 • Welded flange, short cap: LE07, LE11 • Welded flange, long cap: LE08, LE12		
LE10	LE10 Includes either a welded-on or integrated flange with seal onto receptacle Other mods: • Sealed flange, short cap CL09, LE01, LE05, LE06, LE09, LE17, LE21 • Sealed flange, long cap: BL10, CL07		
P012	Has an enhanced front seal retention resulting in an ultra tight environmental seal. The enhanced seal retention keeps the seal in place during mating and unmating. Requires an enhanced P012 wedge lock. Available in all pin arrangements. Connector housing is black except for the 8 and 12 pin arrangements, where the color is based on the key.	 	

I. Accessories

Several accessory items can be used to complement the connectors such as PVC boots, plastic backshells, neoprene closed cell gaskets, protective dust caps and mounting clips. Accessories are designed to complete the application and meet a wide array of design requirements such as solutions for mounting, providing additional protection, and offering increased aesthetics.

BOOTS

Slip-on boots are not only aesthetically appealing, but also provide increased protection from dirt, paint overspray and pressure washing.



DT12P-BT



DT12S-BT

Part Number Receptacle	Description
DT2P-BT	2pin, Gray
DT2P-BT-BK	2pin, Black
DT2P-BT-YW	2pin, Yellow
DT3P-BT	3pin, Gray
DT3P-BT-BK	3pin, Black
DT3P-BT-YW	3pin, Yellow
DT4P-BT	4pin, Gray
DT4P-BT-BK	4pin, Black
DT4P-BT-YW	4pin, Yellow
DT6P-BT	6pin, Gray
DT6P-BT-BK	6pin, Black
DT6P-BT-YW	6pin, Yellow
DT8P-BT	8pin, Gray
DT8P-BT-BK	8pin, Black
DT12P-BT	12pin, Gray
DT12P-BT-BK	12pin, Black
DT12P-BT-EN	12pin, Gray, Long
DT12P-BT-YW	12pin, Yellow

Part Number Plug	Description
DT2S-BT	2pin, Gray
DT2S-BT-BK	2pin, Black
DT2S-BT-YW	2pin, Yellow
DT3S-BT	3pin, Gray
DT3S-BT-BK	3pin, Black
DT3S-BT-YW	3pin, Yellow
DT4S-BT	4pin, Gray
DT4S-BT-BK	4pin, Black
DT4S-BT-EXT	4pin, Gray, Long
DT4S-BT-YW	4pin, Yellow
DT6S-BT	6pin, Gray
DT6S-BT-BK	6pin, Black
DT6S-BT-RED	6pin, Red
DT6S-BT-YW	6pin, Yellow
DT8S-BT	8pin, Gray
DT8S-BT-BK	8pin, Black
DT12S-BT	12pin, Gray
DT12S-BT-BK	12pin, Black
DT12S-BT-EN	12pin, Gray, Long
DT12S-BT-YW	12pin, Yellow
DT48S-BT	48pin, Gray

Material: PVC

Operating temperature is -29°C to +100°C [-20° to +212°F].



Note:

Boots are received with the end closed. Cut end of boot off to desired length.

PROTECTIVE DUST CAPS

Two versions are available. Slip-on PVC caps and thermoplastic caps provide protection from dirt, paint overspray and pressure washing. The thermoplastic version has a hole for either optional rubber or steel lanyard or mounting screw.



Part Number PVC Dust Cap	Description	Connector Part Number
DT3P-DC	3pin, Gray, Rcpt	DT04-3P
DT4P-DC	4pin, Gray, Rcpt	DT04-4P
DT6P-DC	6pin, Gray, Rcpt	DT04-6P
DT12P-DC	12pin, Gray, Rcpt	DT04-12P*
DT12P-DC-BK	12pin, Black, Rcpt	DT04-12P*
DT12S-DC	12pin, Gray, Plug	DT06-12S*

Material: PVC
Operating temperature is -29°C to +100°C [-20° to +212°F]

Part Number Thermoplastic Dust Cap	Description	Connector Part Number
1011-344-0205	2pin, Plug	DT06-2S
1011-345-0305	3pin, Plug	DT06-3S
1011-346-0405	4pin, Plug	DT06-4S
1011-347-0605	6pin, Plug	DT06-6S
1011-348-0805	8pin, Plug	DT06-08S*
1011-349-1205	12pin, Plug	DT06-12S*

Material: PA66 Black
Operating temperature is -55°C to +125°C [-67° to +257°F]

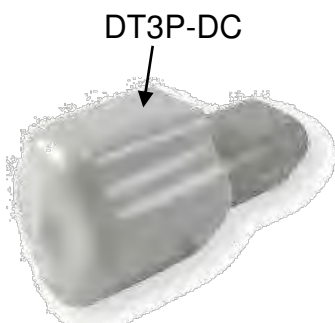

BACKSHELLS

Designed to snap onto and mate with all standard plug and receptacles without modifications that affect the rear of the connector. The rigid, durable backshells offer a high level of protection and allow convoluted tubing to nest within the rear of the backshell. Straight (180°) and right angle (90°) versions and backshells with strain relief for jacketed cable are also available. Since the backshells are designed to work with the standard connectors, tests should be conducted for fit and function of a backshell being used on any part with a modification.

Receptacle Backshells

Part Number	Style	Strain Relief	Tubing Size mm	Connector Part Number
1011-229-0205	180°		6, 7.5, 8.5, 10	DT04-2P
1011-257-0205		X		
1011-230-0205	90°			
1011-258-0205		X		
1011-233-0305	180°			DT04-3P
1011-261-0305		X		
1011-234-0305	90°			
1011-262-0305		X		
1011-237-0405	180°			DT04-4P
1011-265-0405		X		
1011-238-0405	90°			
1011-266-0405		X		
1011-241-0605	180°		8.5, 10, 13	DT04-6P
1011-269-0605		X		
1011-242-0605	90°			
1011-270-0605		X		
1011-245-0805	180°		8.5, 10, 13	DT04-08PX
1011-246-0805	90°			
1011-249-1205	180°		10, 13, 17	DT04-12PX
1011-250-1205	90°			

1011-237-0405



1011-238-0405



X=A, B, C, D key

Material: PA66

Operating temperature is -55°C to +125°C [-67° to +257°F]

Plug Backshells

Part Number	Style	Strain Relief	Tubing Size mm	Connector Part Number
1011-227-0205	180°		6, 7.5, 8.5, 10	DT06-2S
1011-255-0205		X		
1011-228-0205	90°			
1011-256-0205		X		
1011-231-0305	180°			DT06-3S
1011-259-0305		X		
1011-232-0305	90°			
1011-260-0305		X		
1011-235-0405	180°			DT06-4S
1011-263-0405		X		
1011-236-0405	90°			
1011-264-0405		X		
1011-239-0605	180°		DT06-6S	
1011-267-0605		X		
1011-240-0605	90°			
1011-268-0605		X		
1011-243-0805	180°		8.5, 10, 13	DT06-08SX
1011-244-0805	90°			
(1) 1011-247-1205	180°		10, 13, 17	DT06-12SX
(1) 1011-248-1205	90°			
(2) 1028-043-1205	180°		13, 17	DT06-12SX-XXXX

1011-235-0405



1011-236-0405



X=A, B, C, D key

Material: PA66

Operating temperature is -55°C to +125°C [-67° to +257°F]



Note:

1. 1011-247-1205 and 1011-248-1205 can not be used with DT06-12SX-XXXX with Enhanced Key (i.e. B016)
2. 1028-043-1205 may be used with or without enhanced key feature.

GASKETS

Moisture, dirt, salt, sand, and road debris can all work their way into electrical panels through unsealed mounting flanges. These rugged high-quality gaskets form a splash proof seal between the panel face and connector flange to help keep out destructive elements. The gaskets have a thickness of 0.125.

DT12P-L012-GKT



Part Number	Connector Part Number
DT3P-L012-GKT	DT04-3P-L012
DT4P-L012-GKT	DT04-4P-L012
DT8P-L012-GKT	DT04-08PX-L012
DT12P-L012-GKT	DT04-12PX-L012

Material: Closed Cell Sponge

Operating temperature is -57°C to +107°C [-70° to +225°F]

Gaskets are not IP rated

MOUNTING CLIPS

Mounting clips are installed on the receptacle to mount the connector. To meet design needs, the clips are available for several configurations and in plastic, stainless steel, or steel with zinc plating.

Part Number	Mounting Direction	Material	Plating ¹ Color	Mounting Hole mm [in]	Cavity Arrangement
1027-001-0800	Straight	Stainless Steel	None	11 [.433]	DT8pin only
1027-003-1200					DT2,3,4,6,12 DTM, DTP
1027-005-1200				DT8pin only	
1027-006-0800					
1027-002-0800		Steel	Zinc/Yellow	13 [.512]	DT8pin only
1027-004-1200					DT2,3,4,6,12 DTM, DTP
1027-014-0800				8.2 [.323]	DT8pin only
1011-026-0205		PA66	Gray	5.08 [.200]	DT2,3,4,6,12 DTM, DTP
1011-027-0805					DT8pin only
1011-030-0205			Black	T-Stud Mount	DT2,3,4,6,12 DTM, DTP
1011-310-0205 ² 1924487-2	Fir-Tree Mount			DT2,3,4,6,12 DTM, DTP	
1027-008-1200	Side	Steel	Zinc/Yellow	11 [.433]	DT2,3,4,6,12 DTM, DTP
1027-017-1200				8.2 [.323]	



Note:

1. Zinc is RoHS compliant
2. 1011-310-0205 has 50N [11.2lbf] connector retention



Straight Hole Mount



Side Hole Mount

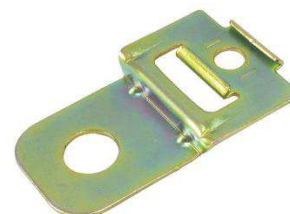

Straight
Hole Mount



T-Stud Mount



Fir-Tree Mount



AS16 Fir-Tree
Mount

3.4. Contact Insertion

1. The crimped contact must meet these specifications:

- 114-151000 DEUTSCH size 16 S&F contacts
- 114-151001 DEUTSCH size 16 S&F contacts
- 114-151004 DEUTSCH solid contacts

2. Grasp crimped contact approximately 25.4 [1.0] behind the contact crimp barrel and hold the connector with grommet facing you.

3. Push contact straight into grommet until positive stop is felt. The contact will lock into place. A slight tug on wire will confirm that is properly locked in place.

RECEPTACLE

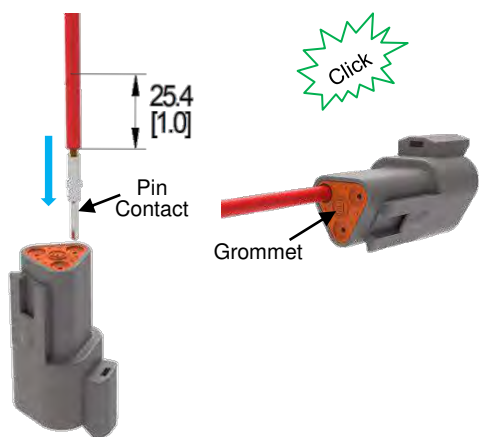

PLUG

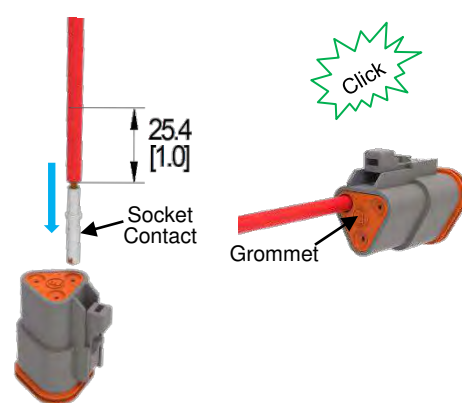

- i** Note:
1. Pins used in receptacle, Sockets used in plug
 2. Wire insulation outside diameter must meet connector wire sealing range per section 3.3.E.
 3. Insertion tool, M15570-16 (size 16) may be needed for ≤ 20 AWG wire.
 4. Front seal must be present and properly seated prior to contact insertion.

4. Once all the contacts are in place, insert the wedge lock until it snaps into place. For the receptacle, the DT-RT1 or small long nose pliers may be used to assist in locking into place. For the plug, wedge lock may be locked in place by hand.

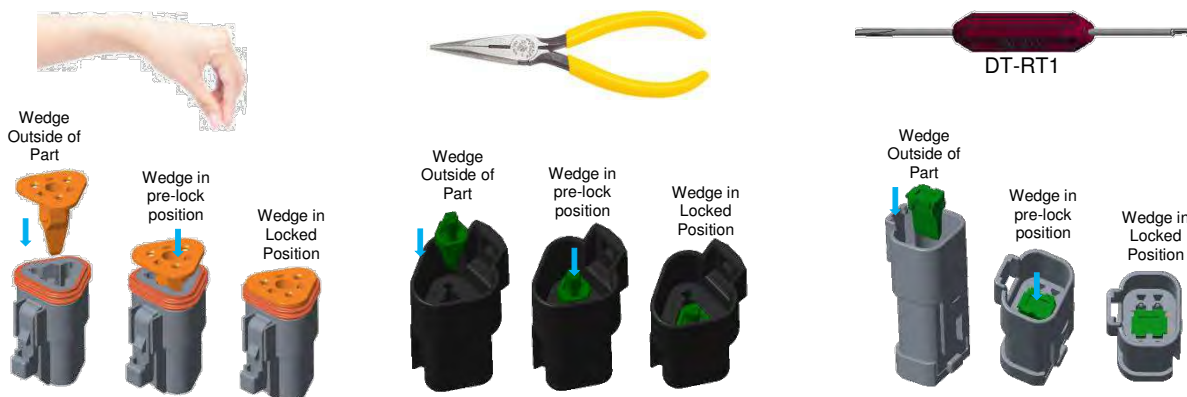



3.5. Contact Insertion Tool

Insertion tools are used to help insert small gage wire contacts into connectors that utilize a round shoulder contact retention system. Insertion tool are compact, easy-to-use and made with durable plastic to insert wire contact without damage to wire, insulation, rear grommet seal or connector housing.

USING THE TOOL

1. Insert the wire contact into the colored end wire entry slot and gently pull back until the contact locking shoulder is against tool.
2. Push the tool/wire contact assembly into the connector rear until the contact is felt snap into position within the retainer.
3. While holding the wire forward, gently pull tool out.
4. A slight tug on wire will confirm the contact is properly locked in place.

Contact Size	Part Number	Mil-Spec	Color Insertion	Insertion Tool
16	M15570-16	M81969/14-03	Blue	

 **Caution:** Do not twist or insert the insertion tool at angle; otherwise, damage to the cavity retention finger(s) will result.

3.6. Contact Removal

DEUTSCH DT-RT1 multi-use tool has a small hook on one end for wedge lock removal and a small screwdriver on the other end to push back the locking fingers and release the contact. The tool is designed to extract individual DEUTSCH solid and stamped and formed (S&F) pin and socket contacts from front-release connectors. See 408-151008 for more information.

A. Removing Socket Contact

1. Slide the screwdriver tip of removal tool under the wedge lock, and by evenly lifting it, remove wedge from the connector.

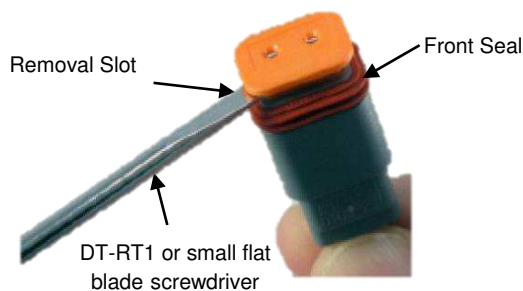

 **Caution:** Be careful not to damage the front seal of the plug connector. Replace if necessary

2. Insert the screwdriver tip of the removal tool into the contact cavity of the contact to be removed to release the locking finger.

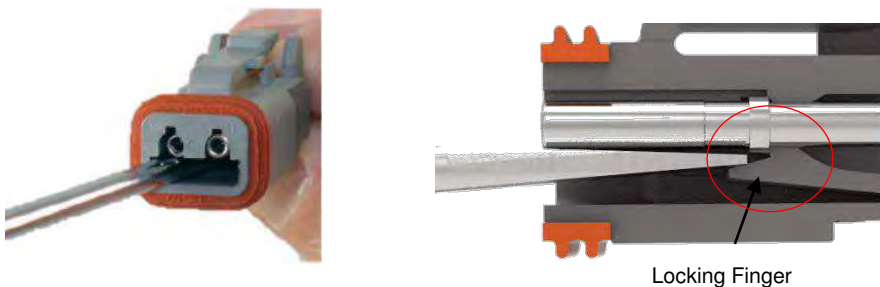

3. Pull the wire until the contact is removed. If there is no end cap on the connector, it may be necessary to hold the rear grommet in place with fingers while removing the contact.

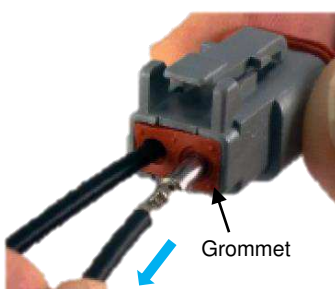

Note:
If rear grommet comes out, inspect it for cuts, cracks or other damage. Replace if necessary. Reinstall

B. Removing Pin Contact

1. For 2, 4, 6, and 12 pin, insert the hook tip of the DT-RT1 or equivalent in the wedge removal slot, grasp the wedge lock, then pull wedge straight out of the connector. For 3 and 8 pin, as well as 2 and 4 pin keyed wedge locks, use small long nose pliers to grasp the wedge lock post, then pull wedge straight out of the connector.

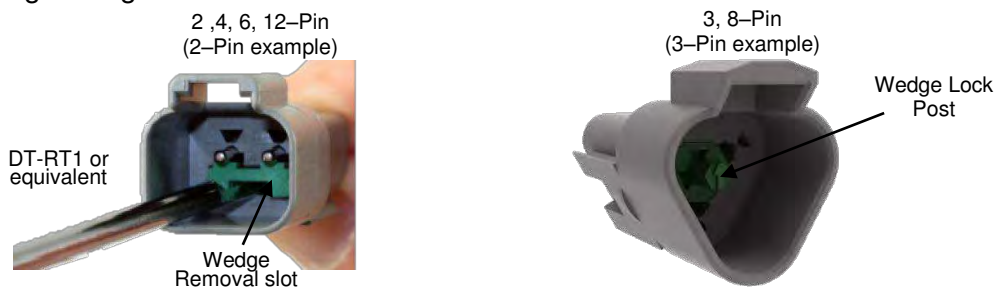

2. Insert the screwdriver tip of the DT-RT1 or equivalent into the contact cavity of the contact to be removed to release the locking finger.



3. Pull the wire until the contact is removed. If there is no end cap on the connector, it may be necessary to hold the rear grommet in place with fingers while removing the contact.

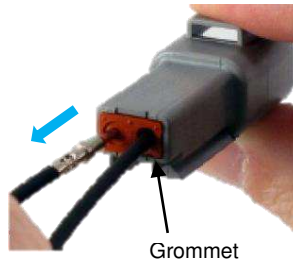

Note:

If rear grommet comes out, inspect it for cuts, cracks or other damage. Replace if necessary. Reinstall

3.7. Sealing Plug, Locking Sealing Plug and Keying Pin Installation and Removal.

114017, 776363-1 Sealing Plug (N-Seal or E-Seal)

Step 1:

Holding the sealing plug with large diameter end away from the connector, gently apply downward pressure to force the sealing plug into the cavity.

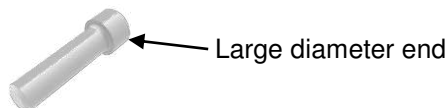

Step 2:

With perpendicular motion, apply downward pressure to the large diameter end of the sealing plug.



Note:

The large diameter end must be flush with cavity opening. Do not push all the way through.

Step 3:

Apply pressure until sealing plug is forced to stop by contact with rear grommet or cap. Visually inspect the sealing plug large diameter end to confirm it is flush with cavity opening. Do not push all the way through. If multiple sealing plugs are used close together, the large ends may not sit flush due to tight spacing. Maximum allowable distance from top of sealing plug to grommet surface is 6.35 [.250] Max, maximum allowable distance from top of sealing plug to short cap surface is 5.08 [.200].



Note:

Sealing plug may be used with long caps, but may be difficult to remove.



Note:



For 2 and 3 pin, the head of the sealing plug can fit into the opening of the short cap, but may protrude past the top of the cap a maximum of 3.81 [.150].

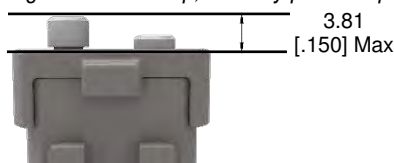

Step 4:

To remove sealing plug from connector, grasp the large diameter end with fingers or small long nose pliers and pull until sealing plug is removed. If there is no end cap on the connector, it may be necessary to hold the rear grommet in place with fingers while removing the sealing plug.



Note:
If rear grommet comes out, inspect it for cuts, cracks or other damage. Replace if necessary. Reinstall

0413-204-2005, 776364-1 Sealing Plug (E-Seal only)

Step 1:

Holding the sealing plug with large diameter end away from the connector, gently apply downward pressure to force the sealing plug into the cavity.

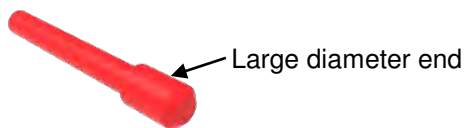

Step 2:

With perpendicular motion, apply downward pressure to the large diameter end of the E-Seal sealing plug.

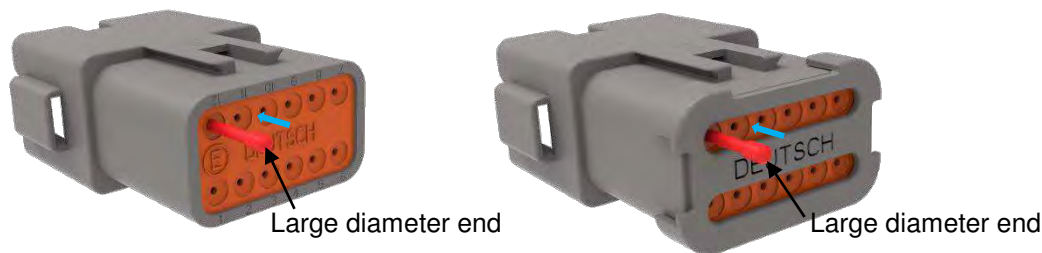

Note:
The large diameter end must be flush with cavity opening. Do not push all the way through.

Step 3:

Apply pressure until sealing plug is forced to stop by contact with rear grommet. Visually inspect the sealing plug large diameter end to confirm it is flush with cavity opening. Do not push all the way through. Maximum allowable distance from top of sealing plug to grommet surface is 5.60 [.220] Max, maximum allowable distance from top of sealing plug to short cap surface is 4.31 [.170].

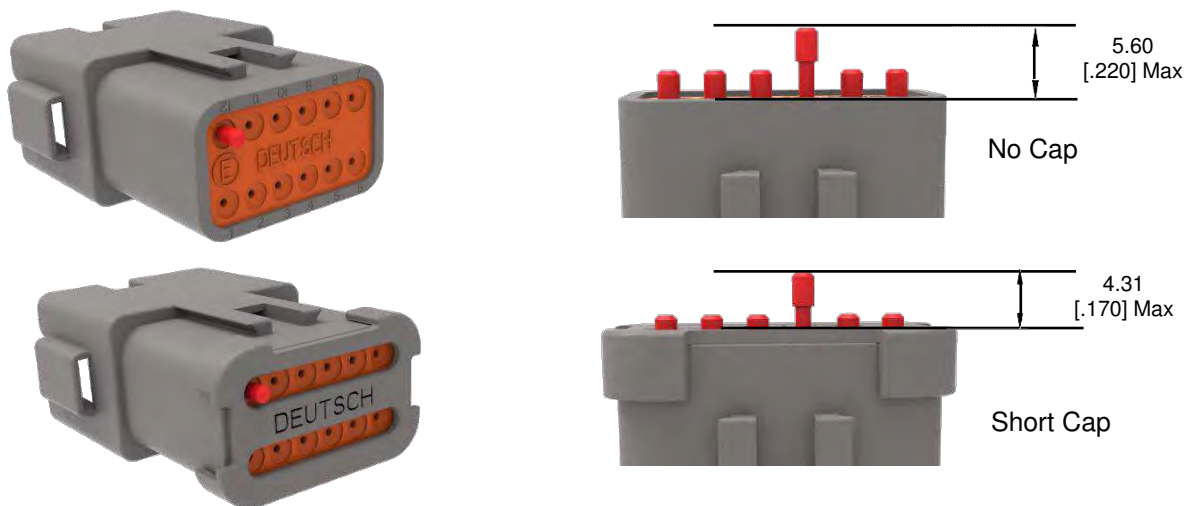

Note:
Sealing plug may be used with long caps, but may be difficult to remove.



Step 4:

To remove sealing plug from connector, grasp the large diameter end with fingers or small long nose pliers and pull until sealing plug is removed. If there is no end cap on the connector, it may be necessary to hold the rear grommet in place with fingers while removing the sealing plug.

Note:

If rear grommet comes out, inspect it for cuts, cracks or other damage. Replace if necessary. Reinstall

0413-217-1605 Locking Sealing Plug (N-Seal or E-Seal)
Step 1:

Holding the sealing plug with locking shoulder end towards the connector, gently apply downward pressure to force the sealing plug into the cavity.

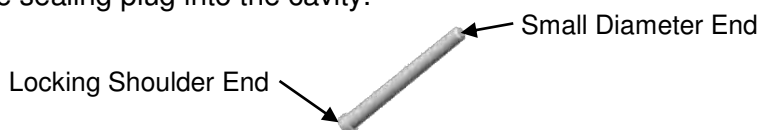
Step 2:

With perpendicular motion, apply downward pressure to the small diameter end of the sealing plug.

Step 3:

Apply pressure until sealing plug locks into place. A slight tug on the sealing plug will confirm it is locked into place. Allowable distance from top of sealing plug to connector surface is shown below.

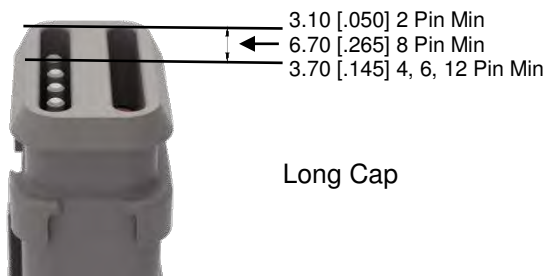
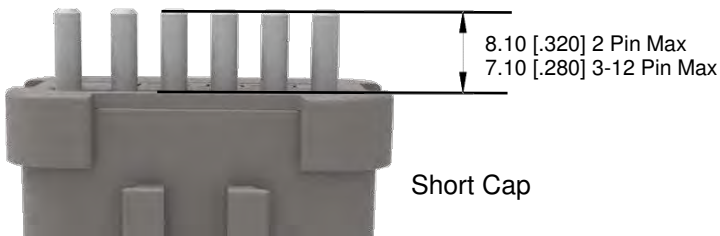
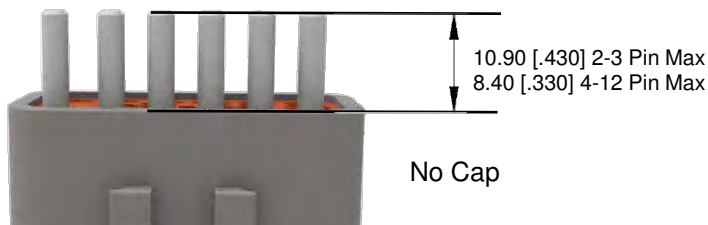

Step 4:

To remove locking sealing plug (keying pin) from connector, first release the locking finger similar to step 2 of contact removal. Then, grasp the end of the locking sealing plug (keying pin) with fingers or small long nose pliers and pull until it is removed. If there is no end cap on the connector, it may be necessary to hold the rear seal grommet in place with fingers during removal.



Note:
If rear grommet comes out, inspect it for cuts, cracks or other damage. Replace if necessary. Reinstall

0413-215-1605 Keying Pin (N-Seal or E-Seal)

Step 1:

Holding the keying pin with large diameter end towards the connector, gently apply downward pressure to force the sealing plug into the cavity.

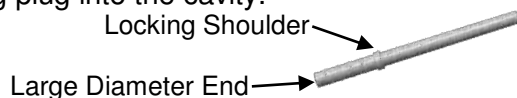

Step 2:

With perpendicular motion, apply downward pressure to the small diameter end of the keying pin.

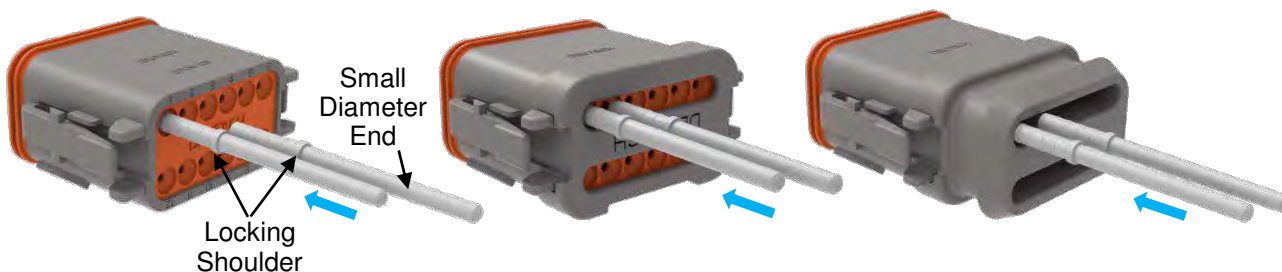

Step 3:

Apply pressure until keying pin locks into place. A slight tug on the keying pin will confirm it is locked into place. Allowable distance from top of keying pin to connector surface is shown below.



Step 4:

To remove keying pin from connector, first release the locking finger similar to step 2 of contact removal. Then, grasp the end of the keying pin with fingers or small long nose pliers and pull until it is removed. If there is no end cap on the connector, it may be necessary to hold the rear seal grommet in place with fingers during removal.

i *Note:*
If rear grommet comes out, inspect it for cuts, cracks or other damage. Replace if necessary. Reinstall

3.8. Connector Mating

2,3,4,6-pin: To mate the plug and receptacle align the plug latch with the receptacle latch box. Then push plug into the receptacle until there is an audible and tactile click. Verify plug latch is in full latched position.

8 and 12-pin: To mate the plug and receptacle, first make sure both plug and receptacle are same key (i.e. A,B,C,D) next align the plug keys with the receptacle keyways. Then push plug into the receptacle until there is an audible and tactile click. Verify both plug latches are in full latched position.

2, 3, 4, 6-Pin

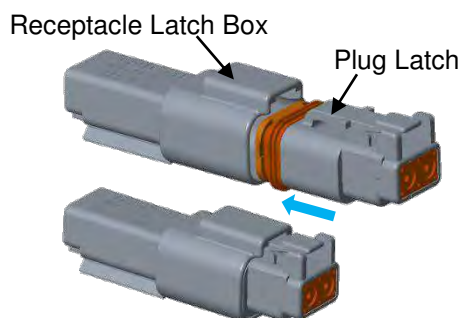

8,12-Pin

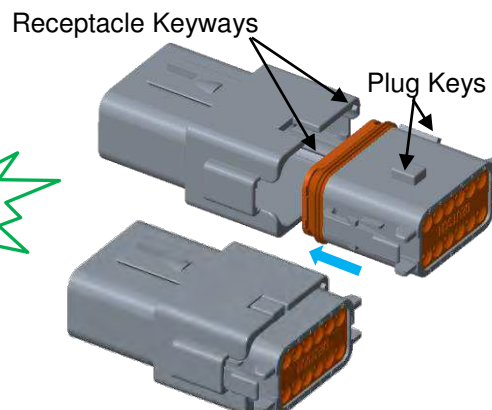

3.9. Connector Unmating

To unmate the plug from the receptacle, push the plug latch(es) until a hard stop is felt. Pull the plug from the receptacle until they are fully separated.

2, 3, 4, 6-Pin

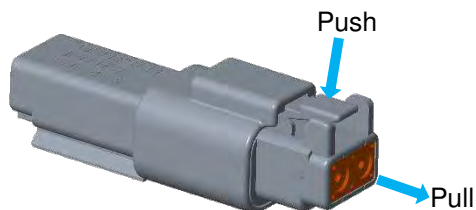

8, 12-Pin

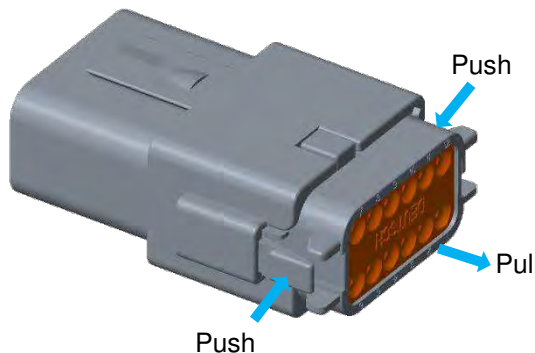

! *Caution:*
Be careful not to damage the front seal of the plug connector. Replace if necessary

3.10. Backshell, Boot, Gasket, Protective Dust Cap, Mounting Clip Installation and Removal

See section H for part numbers.

BACKSHELL - PLUG

1. First, slide the backshell over the wires. Then, insert the wires into the connector. Next, align the opening on the backshell with the plug latch and push the backshell straight onto the back of the connector until a positive stop and a snap is felt. Verify backshell plug snap is fully engaged on plug latch protectors.

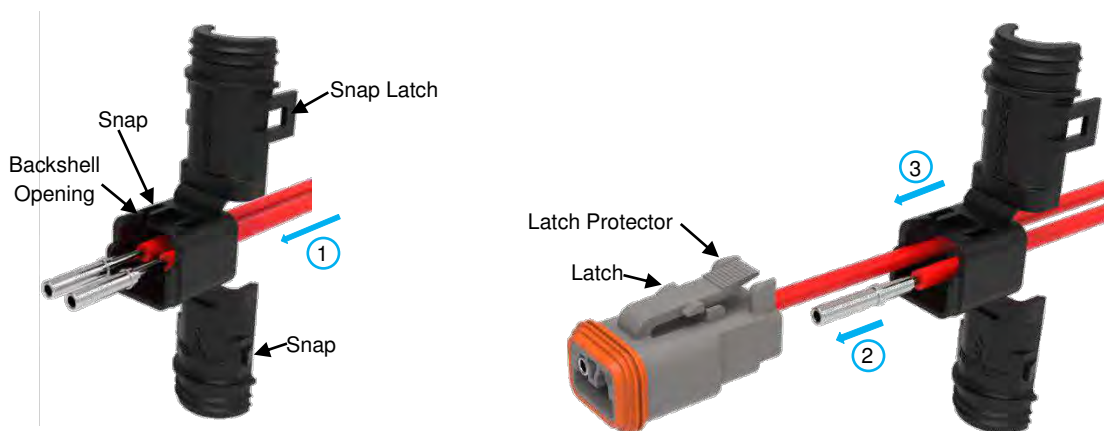

2. To close the backshell, rotate backshell halves together lining up the two snap and snap latches. Before snapping shut, make sure convoluted tubing (if used) is captured within the inner grooves. If no convoluted tubing is used, make sure no wires are pinched in the backshell. If needed, install shrink tubing and/or tie wrap. Cut off excess.

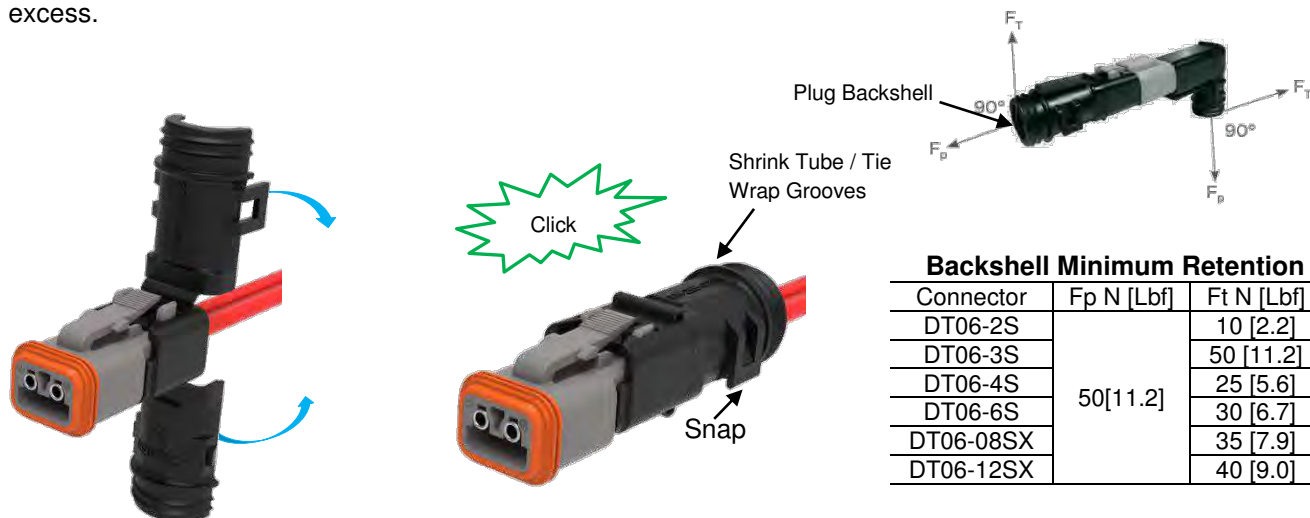

Backshell Minimum Retention		
Connector	Fp N [Lbf]	Ft N [Lbf]
DT06-2S	50 [11.2]	10 [2.2]
DT06-3S		50 [11.2]
DT06-4S		25 [5.6]
DT06-6S		30 [6.7]
DT06-08SX		35 [7.9]
DT06-12SX		40 [9.0]

3. To open the plug backshell, disengage the two snap latches by wedging a DT-RT1 tool or small flat head screwdriver under the snap latch, lift until disengaged then pry the backshell open.



Caution:
Be careful not to break the snap latch.

4. To remove the backshell from plug housing, grasp the backshell and pull hard to rear. It may be necessary to pry the snaps on the backshell outward from plug latch protectors.



1028-043-1205 Enhanced Key Backshell.

Fits onto any 12-Pin plug with or without enhanced key modification, such as B016.

1. To install the backshell, it must first be in the open position as shown. Slide the half of the backshell with the tall snaps onto the back of the plug.

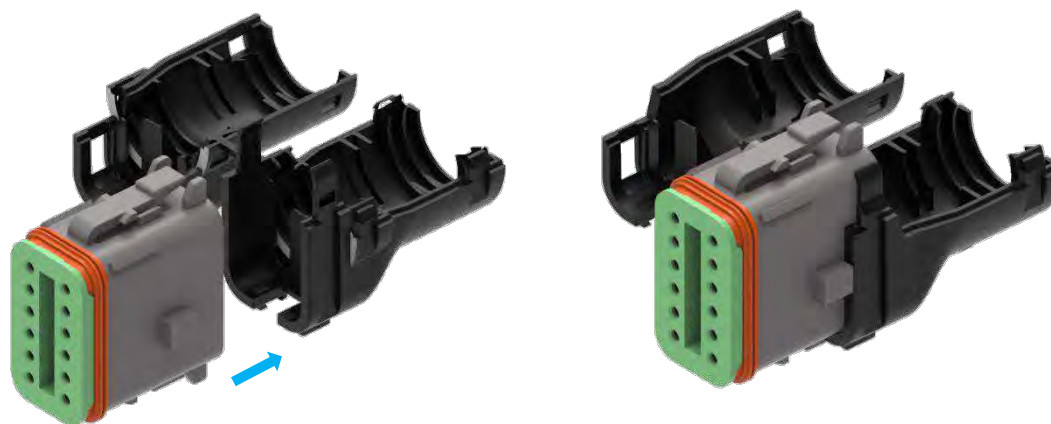

2. To close the backshell, rotate the other half onto the back of the plug while bringing the two halves together. Before snapping shut, make sure convoluted tubing (if used) is captured within the inner grooves. If no convoluted tubing is used, make sure no wires are pinched in the backshell. There are four snaps that need to engage in order to properly snap shut the backshell.

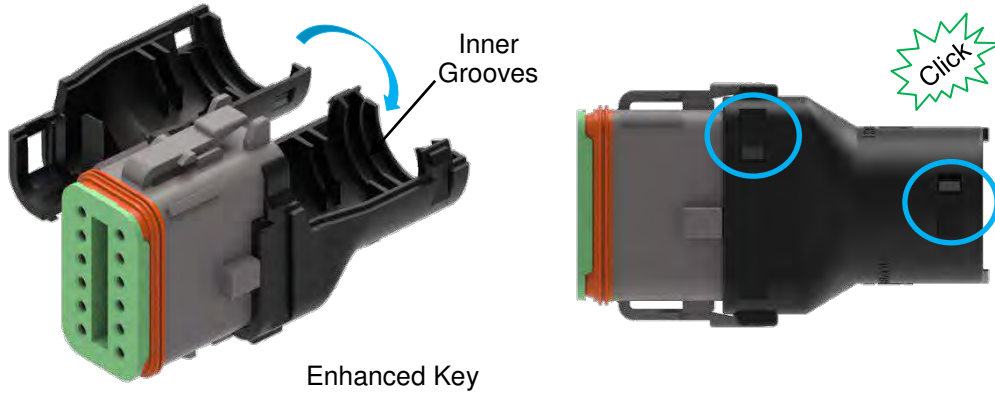

3. To open the backshell, disengage all snaps by wedging a DT-RT1 tool or standard flat head screwdriver under the snap latch, lift until disengaged, then pry the backshell open. Backshell can then be slid off of the plug.

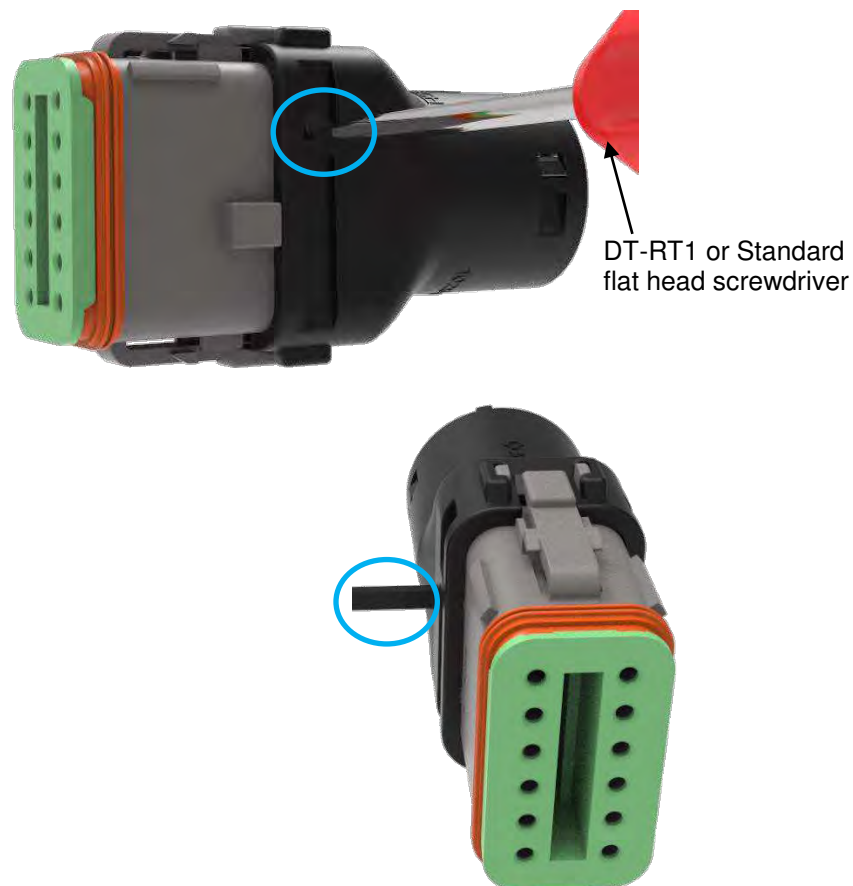

i *Note:* 1028-043-1205 backshell is equipped with a break-away hinge. After backshell is closed onto the plug, the hinge may be broken off and discarded.

BACKSHELL - RECEPTACLE

1. First, slide the backshell over the wires. Then, insert the wires into the connector. Next, align the mounting feature of the backshell with the mounting feature of the connector and push backshell straight onto the back of the connector until a positive stop and a snap is felt. A slight tug will confirm that the backshell is properly locked in place.



2. To close the backshell, rotate backshell halves together lining up the two snap and snap latches. Before snapping shut, make sure convoluted tubing (if used) is captured within the inner grooves. If no convoluted tubing is used, make sure no wires are pinched in the backshell. If needed, install shrink tubing or tie wrap and cut off excess.



Backshell Minimum Retention Force

Connector	Fp N[Lbf]	Ft N[Lbf]
DT04-2P	50[11.2]	10[2.2]
DT04-3P		50[11.2]
DT04-4P		25[5.6]
DT04-6P		30[6.7]
DT04-08P*		35[7.9]
DT04-12P*		40[9.0]

3. To open the receptacle backshell, disengage the two snap latches by wedging a DT-RT1 tool or small flat head screwdriver under the snap latch, lift until disengaged then pry the backshell open.



i Note:
Receptacle backshell is not removable.

BOOT

Step 1. Cutoff the end of the boot to desired length.

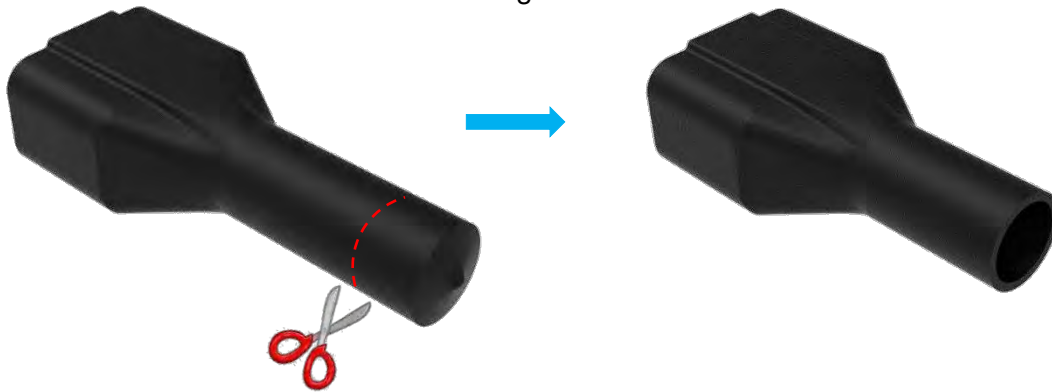

Step 2. Slide the boot over the wires.

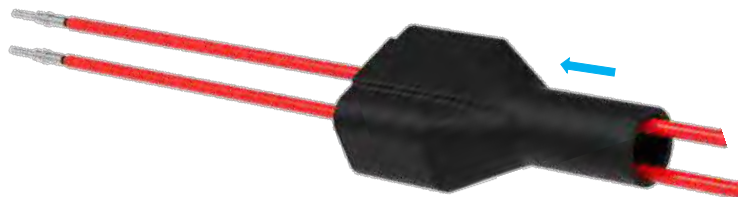

Step 3. Insert the wires into the connector.



Step 4. Slide boot down the wires and onto the connector.

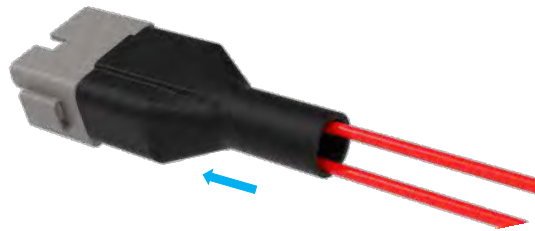

Step 5. If needed, attach a tie wrap on the end of the connector and boot. Trim tie wrap as needed.

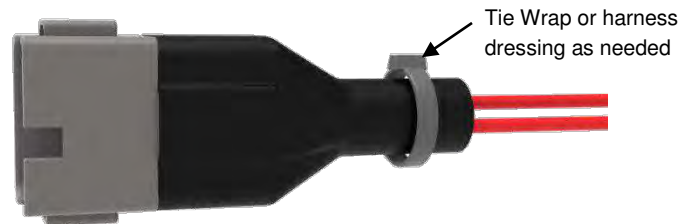

Note:
Do not put excessive stress on the boot to prevent boot from coming off connector.

GASKET

Install the gasket onto the connector on the desired side of the flange. Install on the front side for rear mount, on the back side for front mount. Next install into panel mounting hole. See section 3.11 for panel installation.

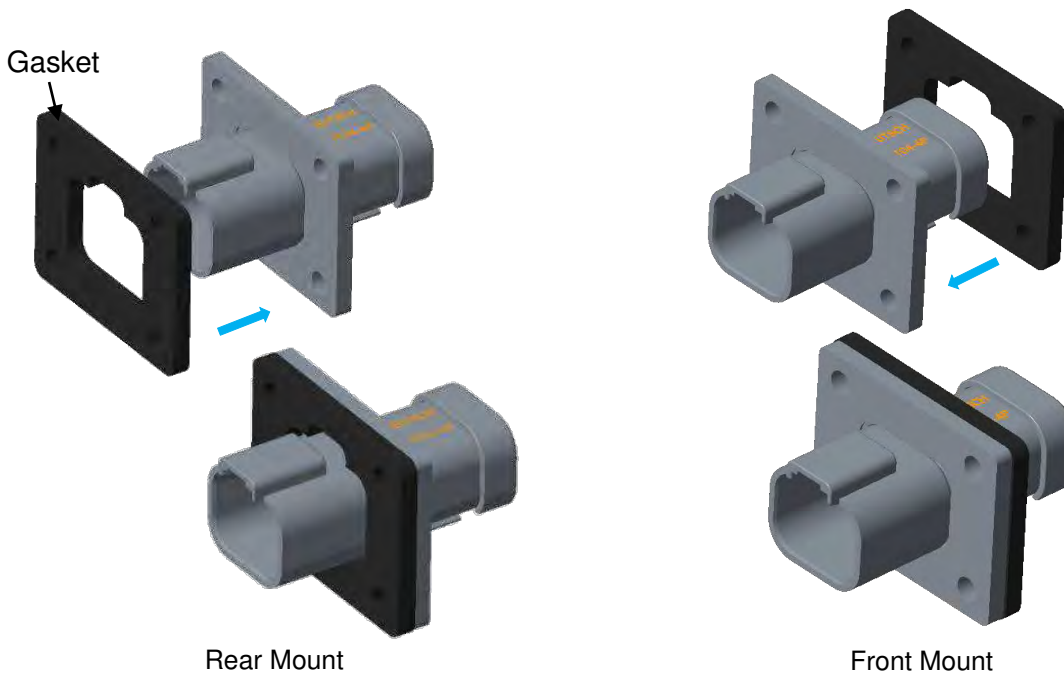

PROTECTIVE DUST CAP- RECEPTACLE

Install the protective dust cap onto the front of the receptacle by aligning the latch box of the connector with the latch box openings on the dust cap and slide onto the connector until a stop is felt. Remove the dust cap by sliding it off the connector.

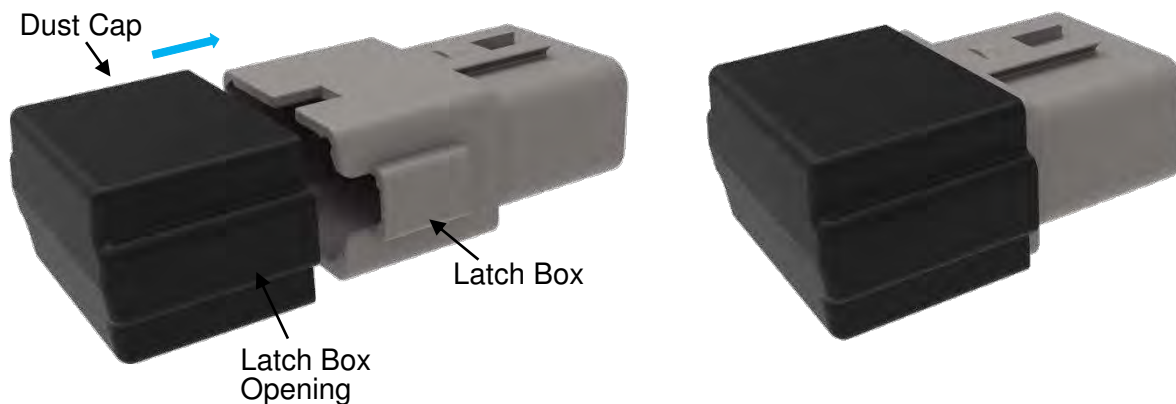

PROTECTIVE DUST CAP- PLUG

The thermoplastic dust cap is mated and un-mated to the plug in the same manner as mating and un-mating the plug to a receptacle. See sections 3.8 and 3.9 for mating and un-mating instructions. Recommended maximum mounting screw torque is 2.82 Nm [25 in-lb].



MOUNTING CLIP - RECEPTACLE

In order to install a clip onto a receptacle, first align the clip mounting features of the housing with the clip. Then push the clip straight onto the back of the connector until a positive stop and a snap is felt. Clip retention force is 89N [20Lbf] minimum, except 1011-310-0205 is 50N [11.2 Lbf] minimum.

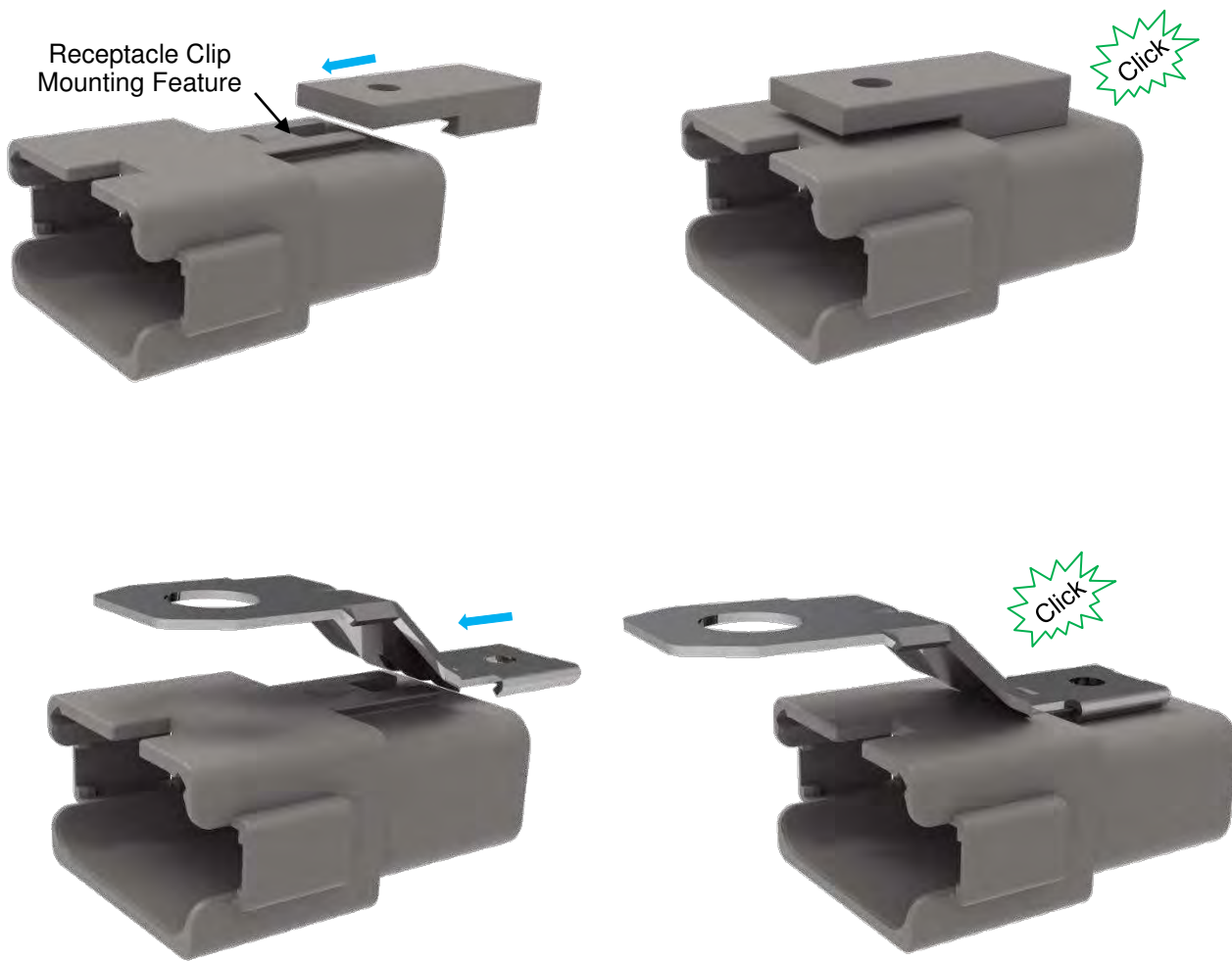



Note:

Mounting clip is removable. Damage to receptacle retention feature may occur.

3.11. Panel Installation

Receptacles with flanges may be mounted to a panel as shown. Refer to product drawings for panel cutout information. Recommended panel surface roughness is RMS 0.8 μ m [32 μ in] or better.

Common Flange Modifications

Modification	Description	Receptacle
L012	Includes a simple welded-on flange onto receptacle to simplify wire routing and assembly. Other mods: <ul style="list-style-type: none"> • Welded flange, no cap: BL04, BL08, CL03, LE14 • Welded flange, short cap: LE07, LE11 • Welded flange, long cap: LE08, LE12 	
LE10	LE10 Includes either a welded-on or integrated flange with seal onto receptacle Other mods: <ul style="list-style-type: none"> • Sealed flange, short cap CL09, LE01, LE05, LE06, LE09, LE17, LE21 • Sealed flange, long cap: BL10, CL07 	

FLANGE – L012 TYPE

Insert wire side of receptacle through the panel cutout for front mount or insert mating side of receptacle through the panel cutout for rear mount. If a gasket is used, ensure the gasket is installed onto the desired side of the flange before inserting connector through the panel cutout. Recommended screw size is M4 [6-32]. Screw length dependent on application. Recommended screw torque is 2.26-2.82 Nm [20-25 in-lb]. Recommended mounting hardware (i.e. flat washers, nuts, screws) are customer supplied. Maximum recommended panel thickness is 16.50 [.650].

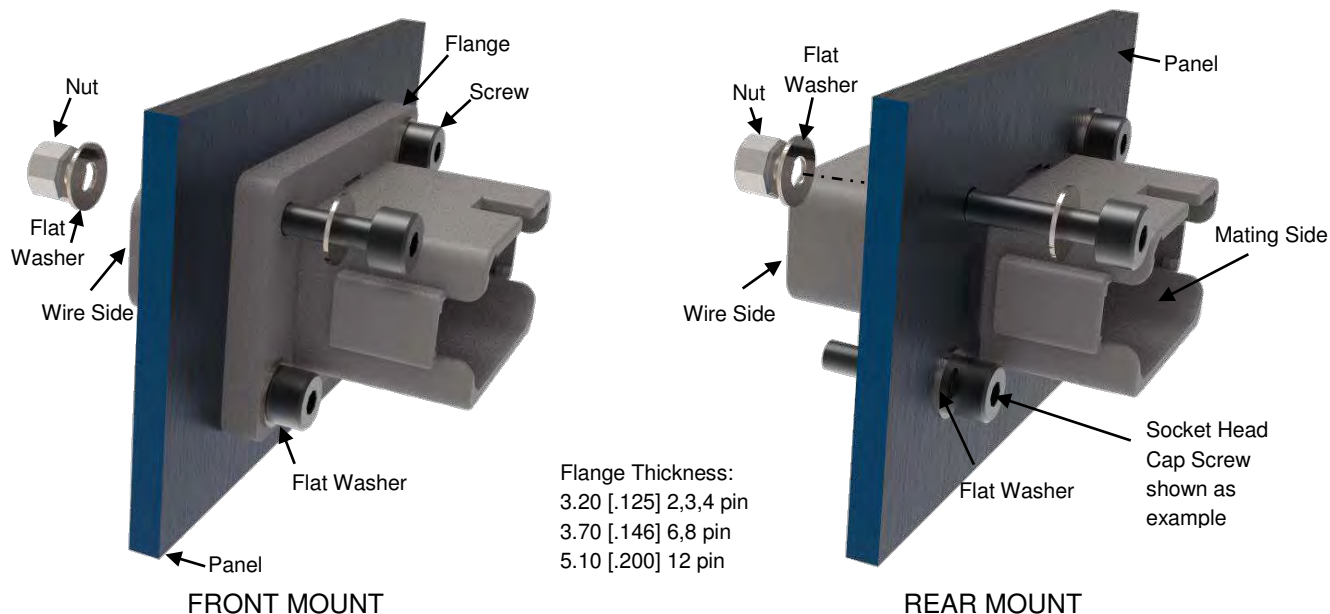

Note:

1. It is recommended to add flat washer under the head of the fastener and nut to prevent damage to flange.
2. Do not over tighten fastener. This will prevent damaged or broken receptacle and/or flange.
3. Do not side load the receptacle. This will prevent damage or broken receptacle and/or flange.
4. Gasket forms a splash proof seal only, see section I for more information.

FLANGE – LE10 TYPE

Insert mating side of receptacle through the panel cutout. Included flange seal is intended for non-pressurized fluid splash only. Recommended screw size is M6. Recommended screw torque is 7-10 Nm [62-88 in-lb]. Screw length dependent on application. Recommended mounting hardware (i.e. flat washers, screws) are customer supplied.

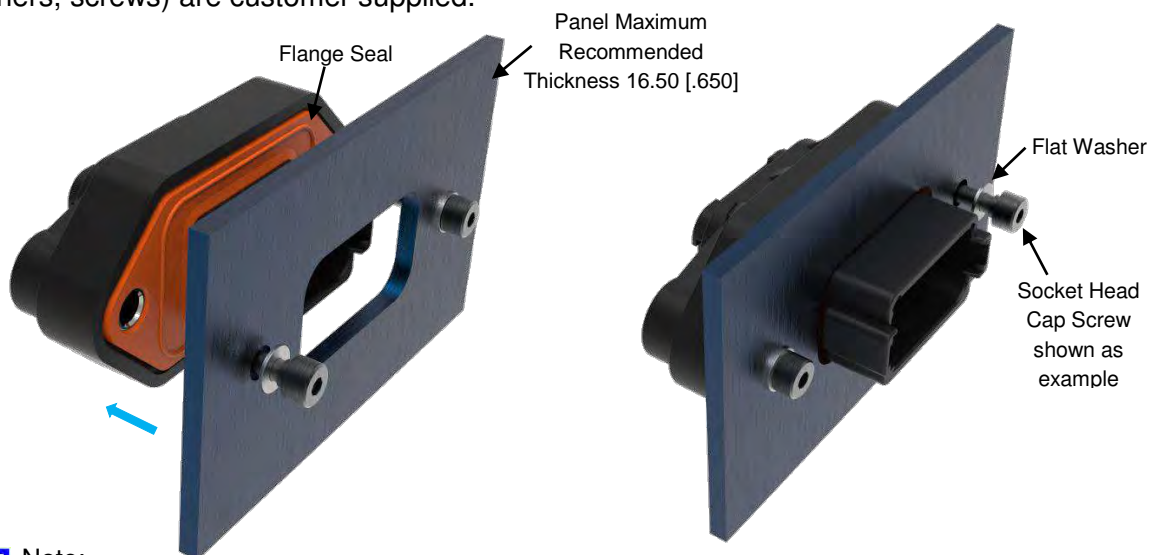

- i** Note:
1. It is recommended to add flat washer under the head of the fastener to prevent damage to flange.
 2. Do not over tighten fastener. This will prevent damaged or broken receptacle and/or flange.
 3. Do not side load the receptacle. This will prevent damage or broken receptacle and/or flange.

3.12. Replacement and Repair

Damaged or defective connectors must not be used. These connectors cannot be repaired.

4. QUALIFICATION

Refer to product specification 108-151009 for qualification and approved agency.

5. TOOLING

Refer to the following application specifications for reference on all pin and socket contact termination tooling.

114-151000, DEUTSCH Size 16 S&F

114-151001, DEUTSCH Size 16 S&F

114-151004, DEUTSCH Size 4-20 Solid

The DT-RT1 removal tool is designed to remove secondary wedge locks and contacts from the connectors.



DEUTSCH Removal Tool DT-RT1 for Front-Release Connectors (408-151008)

6. HELPFUL HINTS

Helpful hint

Proper wire outside diameters help provide water tight seals. See Section 3.3.E for sealing ranges.

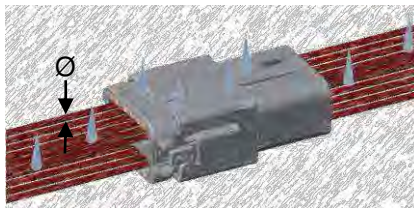

Helpful hint

Proper wire routing assures water tight seal performance. Keep wire straight for 20 mm minimum recommended, unless a plastic backshell is used.

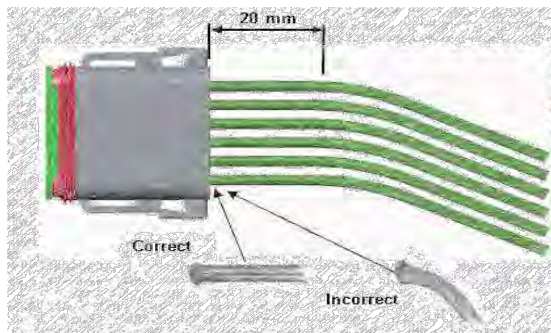

Helpful hint

Making the socket contact side the “hot side” can reduce the danger of electric shock.

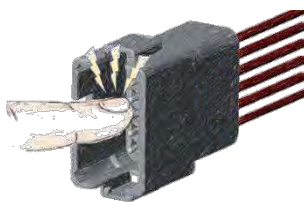

Incorrect

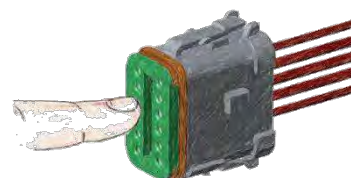

Correct

Helpful hint

Pulling lightly on the wire after it is snapped in place will assure the contact is locked.



Helpful hint

Sealing plugs are used to seal the connector when all the cavities are not used by wires.



Incorrect



Correct

Helpful hint

Mounting connectors horizontally allows proper water drainage.

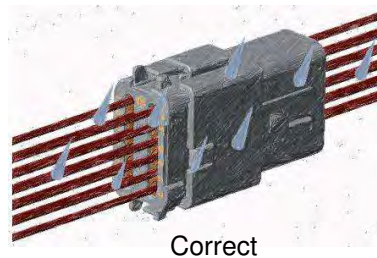
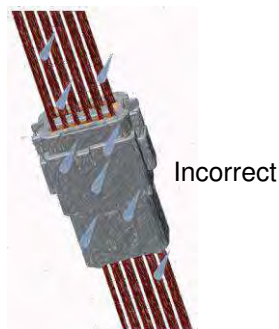

Helpful hint

Attaching the connector to a structure eliminates straining the electrical system in service.

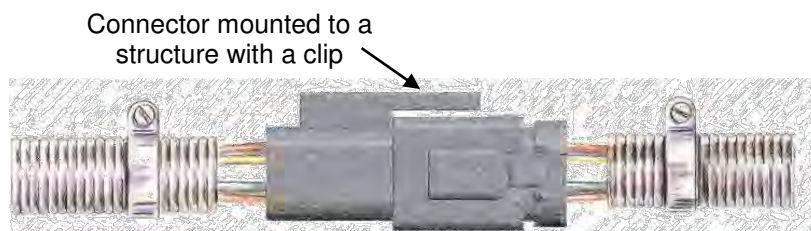

Helpful hint

Tie wraps and tape away from the rear of the connector will allow the wire to be sealed properly.

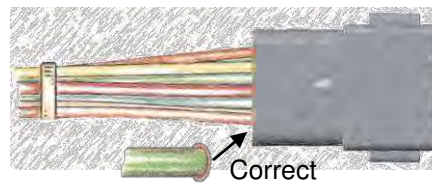
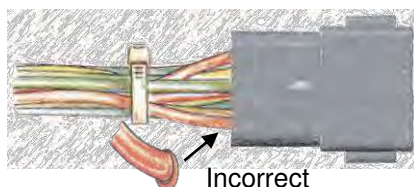

Helpful hint

The middle line of text on the housings can be either "USA", "IPD-USA", "INDUSTRIAL", or blank



Helpful hint

For plugs, use DT-RT1 or small flat screwdriver to gently remove the wedge. (1) Insert screwdriver between wedge and housing, (2) continue to push screwdriver until wedge comes loose, (3) twist screwdriver if necessary to loosen wedge. Take care not to damage the seal.

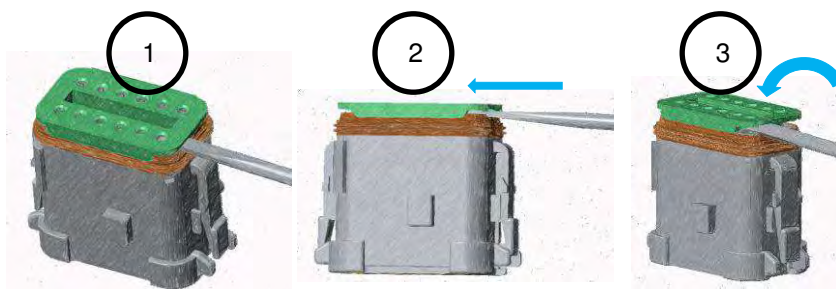

Helpful hint

For plugs, when removing the plastic dust caps, push down on the flange while pulling the cap off to help with un-mating.

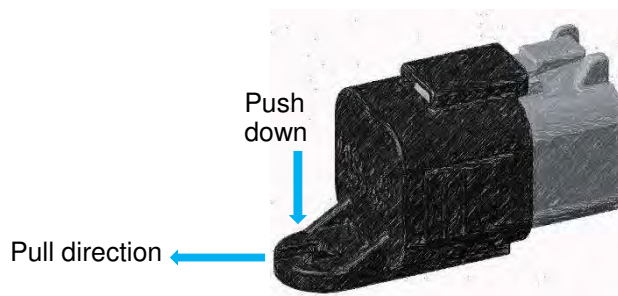

Helpful hint

When installing the W3P wedge lock into the 3 pin receptacle, use the arrow on the wedge to orient it in the housing, the arrow should point up towards the latch box.



7. VISUAL AID

Below shows a typical application of the DT Series Connector. This illustration should be used by production personnel to ensure a correctly applied product. Applications which DO NOT appear correct should be inspected using the information in the preceding pages of this specification and in the instruction material shipped with the product or tooling.

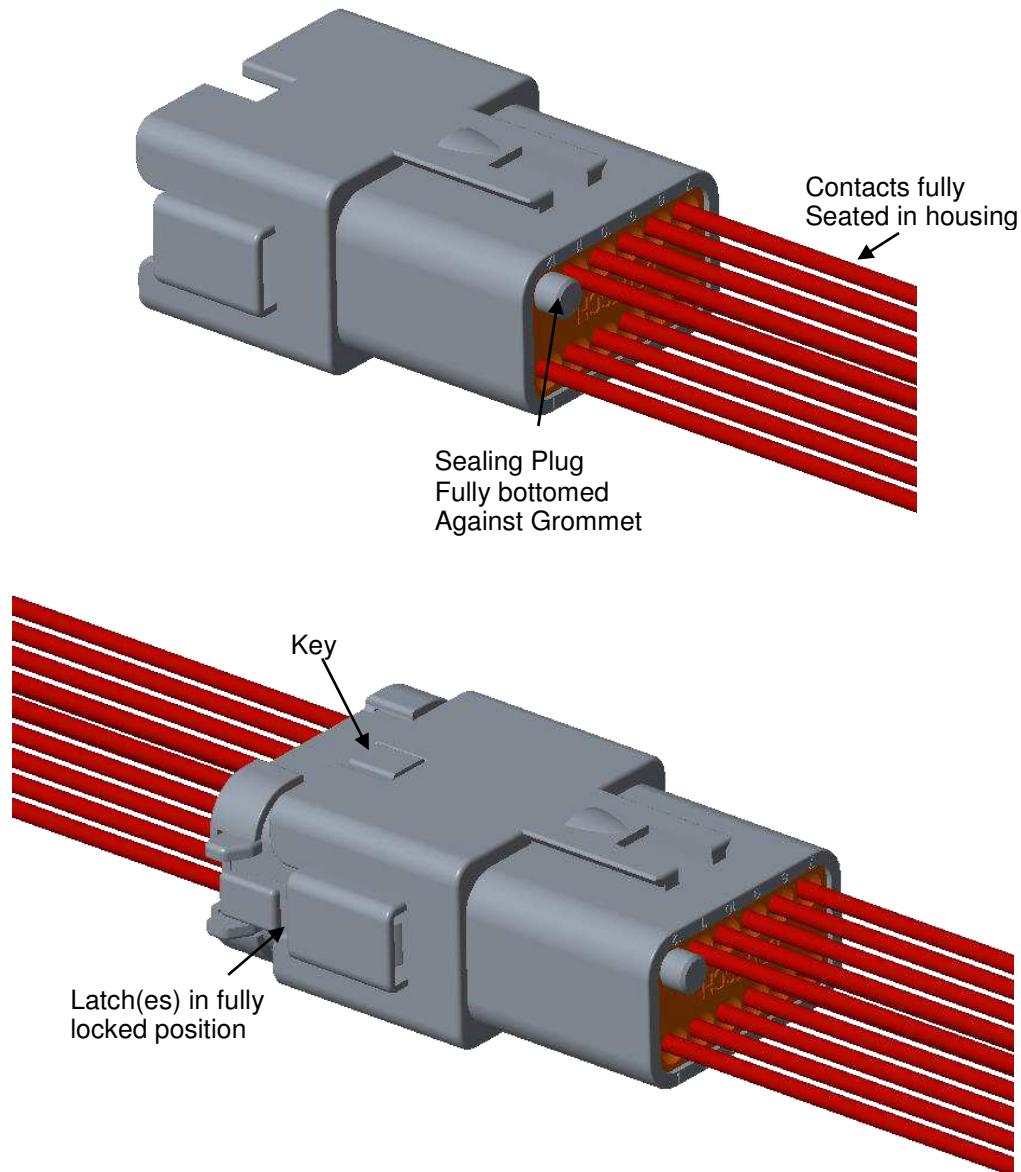

8. REVISION HISTORY

Rev Ltr	Brief Description of Change	Date	Dwn	Apvd
A	Initial Release	11/19/2018	RM	DM
A1	Revised page 15 of 47 Modification, add -B031 Blind Blocked Plug	11/30/2018	JA	DM
A2	Update the page 2 of 47, update the pictures with the correct keys.	01/22/2019	JA	DM
A3	Page 6 - moved topic 1.4. Plug Front Seal Replacement to Page 7. Page 7 - added topic 1.4. Plug Front Seal Replacement. Page 10 - updated the color of grommet. Page 25 - note 4 added (Front seal must be present and properly seated prior to contact insertion). Page 38 - eliminated first comment in topic Boots. Page 39 - fixed typo error. Page 44 - fixed typo error.	04/12/2019	JA	DM
B	Page 41: Corrected the note at bottom of page to read " <i>Mounting clip is removable. Damage to receptacle retention feature may occur.</i> "	01/17/2020	DM	DM