

PRECO[™]
ELECTRONICS

Wireless PreView®
Display
WD7102
Operating Manual



FCC STATEMENT

This device complies with Part 15 of the FCC Rules. Operation is subject to the following two conditions: (1) this device may not cause harmful interference, and (2) this device must accept any interference received, including interference that may cause undesired operation.

Warning: Changes or modifications to this unit not expressly approved by the party responsible for compliance could void the user's authority to operate the equipment.

NOTE: This equipment has been tested and found to comply with the limits of a Class B digital device, pursuant to Part 15 of the FCC Rules. These limits are designed to provide reasonable protection against harmful interference in a residential installation. This equipment generates, uses, and can radiate radio frequency energy and, if not installed and used in accordance with the instructions, may cause harmful interference to radio communications. However, there is no guarantee that interference will not occur in a particular installation. If this equipment does cause harmful interference to radio or television reception, which can be determined by turning the equipment off and on, the user is encouraged to try and correct the interference.

TRADEMARKS

The names of actual companies and products mentioned herein may be the trademarks of their respective owners. Any rights not expressly granted herein are reserved.



CONTENTS

Product Description:2
Installation:3
Mounting the Display:3
Configuring the Display:4
Settings:4
Operation:9
Specifications:12
Troubleshooting:13
Additional Options:14
Warranty Information:15



Product Description

The Preco WD7102 is a robust touch screen display that communicates wirelessly to a compatible PreView Wireless radar sensor. This display provides the machine operator with distinctive and intuitive visible and audible alerts that indicate the detection of an object. These alerts will change as the distance to the object changes.

The WD7102 display has a resistive touch screen that is designed to work through gloves and light amounts of dirt and oil. Unlike smart phones and tablets that will not work with gloves, a firm finger press is needed to make selections.

The WD7102 display features a unique "Touch to Silence" feature that allows the operator to acknowledge and silence the audible alert simply by touching anywhere on the screen.

Although the communication between the WD7102 and PreView sensor is wireless, the WD7102 and PreView sensor still require wired connections to the machine to obtain power for operation.

Safeguard Instructions

Please read the following cautions carefully before using this product. Following these rules prevent users from potential harm caused by product misuse.

Caution:

- Electrical shock or damage to the product may occur if machine power is not turned off during installation.
- Do not clean exterior with solvents as they may damage the product and could potentially cause a fire.
- Do not mount the unit where it would be subjected to extreme vibration or shock.
- Do not disassemble unit as it will void the warranty.



Installation

Installation of the system requires up to three electrical connections – ignition power, ground, and/or reverse. The reverse connection can be skipped if it cannot be found in the cab as the display can be configured to receive the reverse signal from the sensor. However, it is suggested for optimum performance that the display be directly connected to reverse. The first step is to determine the machine cab wiring option. The flow chart below details the two display wiring options.

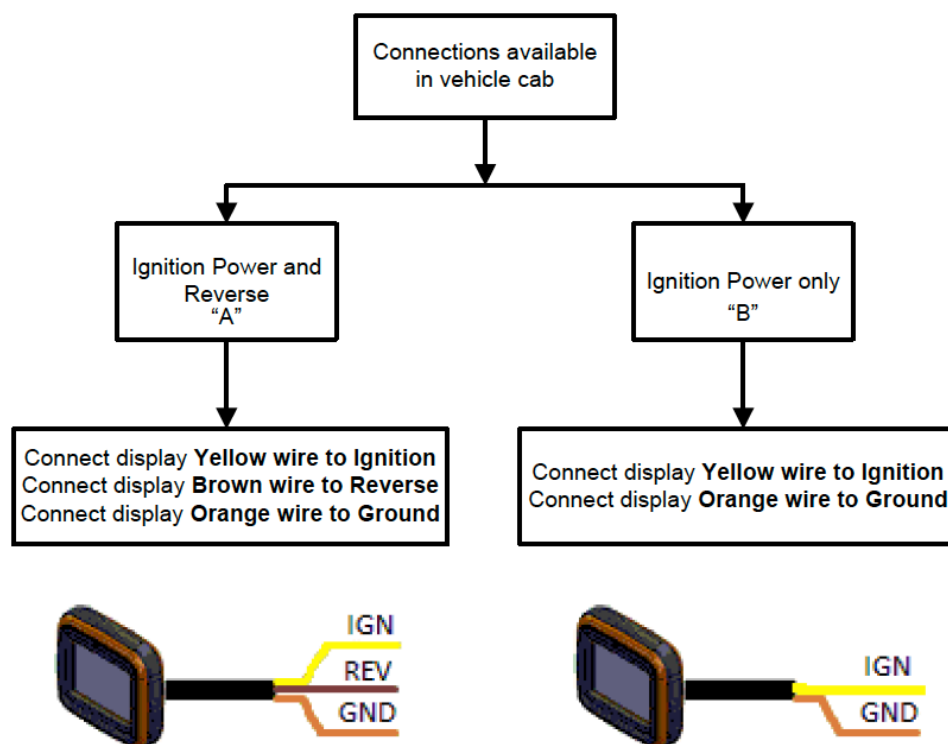

Figure 1. Electrical Connections

Mounting the Display

Using the supplied RAM Mount™ components, select the best spot in the cab for mounting the display. Since the display has the Touch to Silence feature, the display should be within arm's length of the machine operator. A typical mounting location is on the dash where the display doesn't inhibit the drivers' view.



Configuring the Display

Before configuring the display, the display and sensor (see sensor manual for sensor installation instructions) must be installed and powered. After the display powers up, the Home screen will be present.



Figure 2. Configuring the Display

This screen allows access to the system settings and provides display information. The Information icon (?) provides access to the firmware, boot loader, audio file revisions, the display's serial number, and a short functional description of the system. To view the system settings and configure the system, press the gear icon. To return to the Home screen at any time simply press the house icon. When in any of the sub-menus, the previous screen can be reached by pressing the back icon.

Settings

Once the Settings icon has been selected the Enter Passcode screen will be visible as shown below:

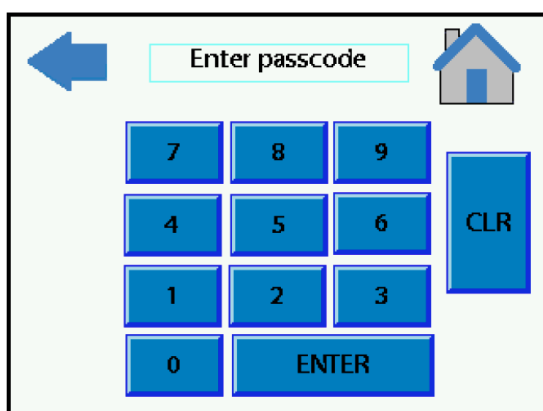
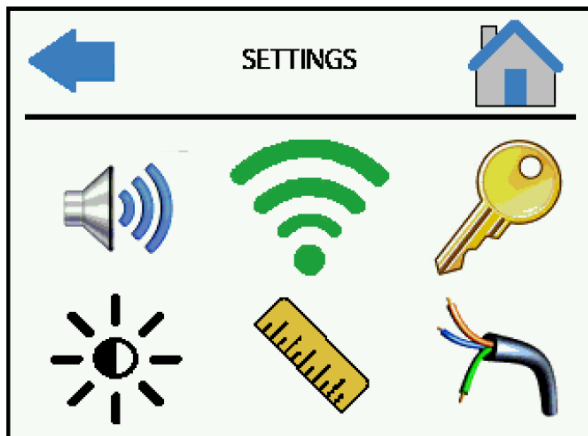

Figure 3. Enter Passcode Screen







The default Passcode is 12345. Once the Passcode has been entered, press the ENTER button to proceed to the Settings screen.



Figure 4. Settings Screen



Quick Guide to the Menu Icons:

-  Volume adjustment
-  Connect a sensor to the display
-  Change the passcode
-  Brightness adjustment
-  Adjust detection reporting ranges
-  System installation configuration

Volume Adjust Screen (Optional)

To adjust the volume, press on the speaker icon . Press and move the slide bar until the appropriate volume is reached. Moving the slide bar to the left reduces the volume and moving the slide bar to the right increases the volume. The volume should be set where the display alerts can be heard above all in cab noises. The volume setting is saved when the menu is exited.

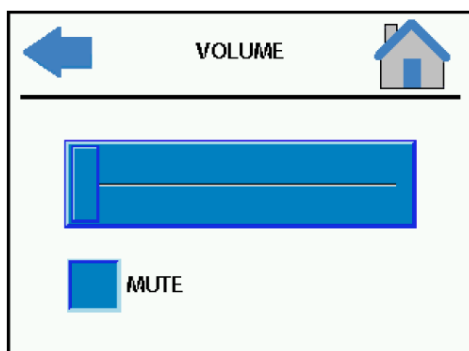



Figure 5. Volume Adjust Screen



Wired Connection Screen (Mandatory)

In order for the system to operate as intended, the display must be told how it was electrically connected during installation. The Wired Connection Screen can be reached by pressing the  icon.

As discussed earlier, there are two wiring options for the display. Select the option that represents how the display was wired by pressing the corresponding blue box.

Figure 6. Display Wired Connection Screen

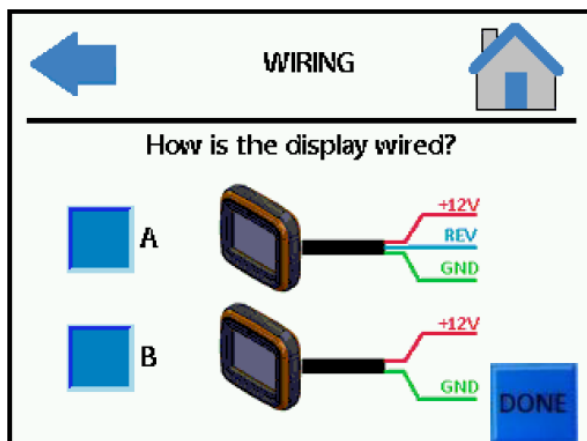

Wireless Connection Screen (Mandatory)

In order for the system to function, the display must be told what wireless PreView sensor to communicate with. To connect the display to the sensor, enter the Wireless Connect screen by pressing the  icon. If the sensor is powered up and within range, it will show up on the screen like in the screen shot below:

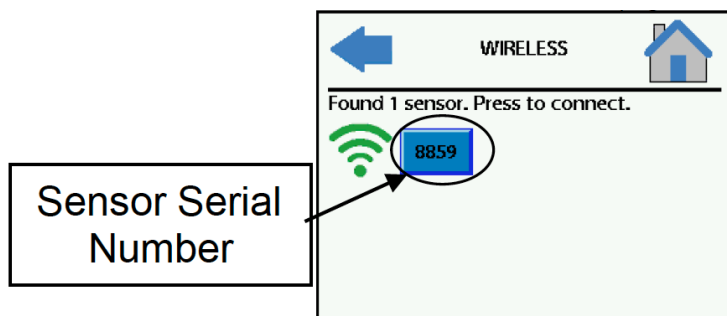

Figure 7. Wireless Connect Screen

Wireless Connection Screen (Mandatory)

Press on the blue box containing the desired sensor serial number to connect to that sensor. After 2-3 seconds the display should connect to the sensor and the on screen message will change to "Currently married to sensor XXXX" (see Figure 8). If multiple sensors show up, choose the serial number that corresponds with the last 4 digits of the sensor serial number on the same machine as the display.

Critical: The sensor must be powered up in order for the display to see it!



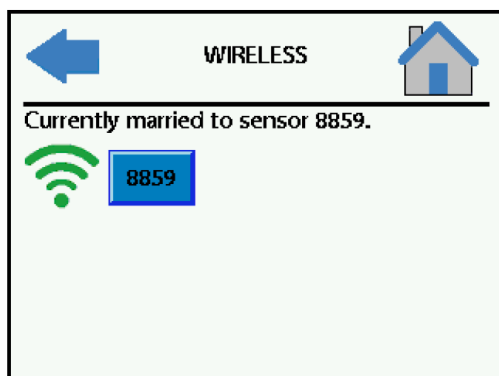

Figure 8. Wireless Connect Screen 2

If the display does not find any sensors to connect to (see Figure 1.8), verify the sensor is wired correctly and powered up (machine should be in reverse). If the sensor is powered up and the display still can't find it, or is having trouble connecting, please see the Troubleshooting section of this manual.

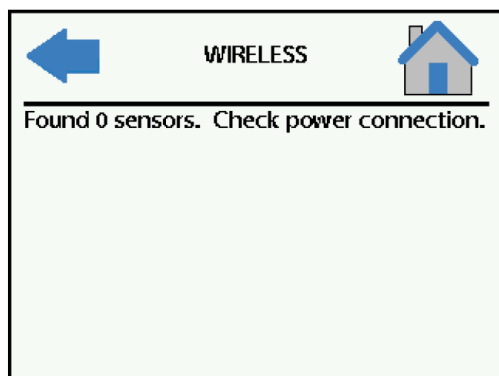



Figure 9. Wireless Connect Screen 3

Change Passcode Screen (Optional)

The Change Passcode screen is used to change the Passcode that grants access to the Settings screen. As mentioned before, the default Passcode is 12345. To open the Change Passcode screen, press on the  icon. The Passcode can be changed to any combination of 5 numbers.

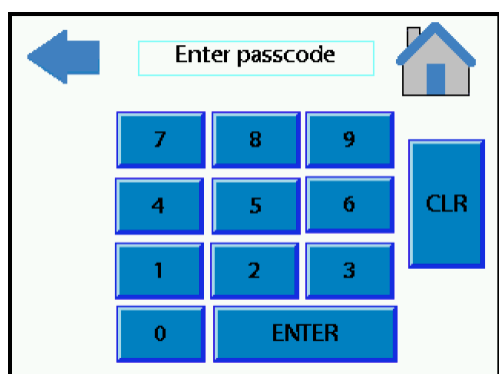



Figure 10. Password Screen



Brightness Screen (Optional)

Press the  icon to enter the Brightness screen. This screen is used to set the default screen brightness. Press and move the slide bar until the appropriate brightness is reached. Moving the slide bar to the left decreases the brightness and moving the slide bar the right increases the brightness. The display will automatically increase or reduce the brightness based on the ambient lighting.

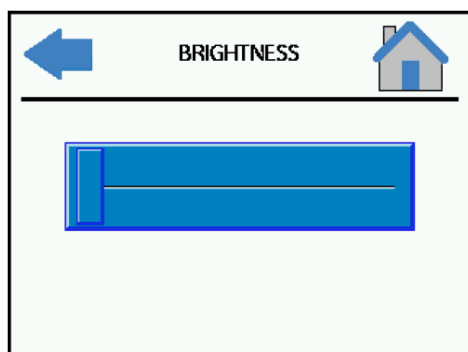





Figure 11. Brightness Screen

Distance Alert Screen (Mandatory)

The Distance Alert screen is used to set the visual and audible warning distances. The Distance Alert screen is entered by pressing the  icon. Adjust the  slide bar to set the maximum detection distance; the available range is between 10-20FT (3-6M). Adjust the  slide bar to set the close-in detection zone visual and audible alert range. This can be set to any value greater than 2FT and up to 4FT less than the maximum detection distance.

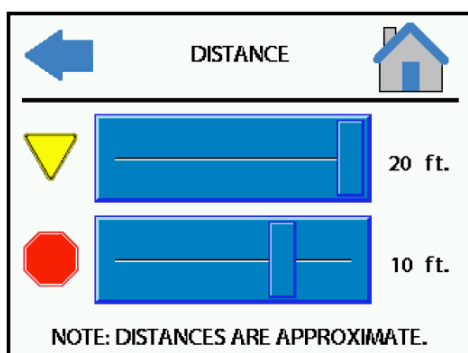

Figure 12. Distance Alert Screen



Operation

Home Screen:

The Home screen is present when the display is powered and the system is not active (Figure 13).

Figure 13. Home Screen, Generic



A couple seconds after power up, the Preco Electronics™ logo will change to an image depicting a truck that is not reversing (Figure 14). When the machine is placed into reverse and the system becomes active the screen will change to the “Active Screen”.

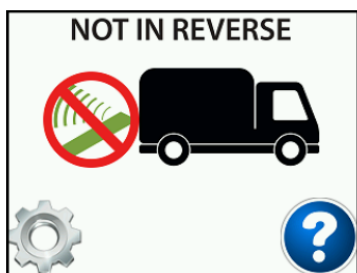

Figure 14. Not In Reverse!

Active Screen:

The Active screen is present when the machine has been placed into reverse and the system is searching for objects in your blind spot. When the sensor is reporting and there are no objects being detected the Active Screen will show a green check mark and make a chime sound every few seconds to notify you that the system is working properly.

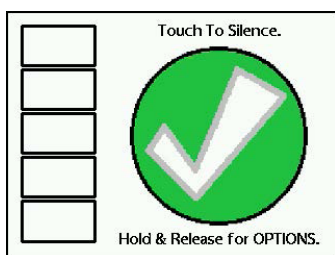
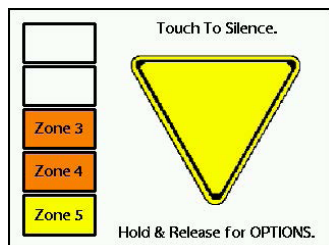

Figure 15. Active Screen, Clear



When the sensor reports a detection within the maximum detection range set in the “Distance Alert Screen” (page 8), the check mark will be replaced by a yellow triangle (Figure 16). The audible will also change to the “Warning” sound to notify you that an object has been detected.

Figure 16. Active Screen, Warning



The display provides three different warnings to the machine operator that change based on the distance to the detected object. 1) The audible warning sound will increase in rate and volume as the machine gets closer to the detected object. 2) The yellow triangle’s flash rate will increase in the same manner as the audible warning. 3) The five zone boxes on the left side of the screen will continue to illuminate until all five boxes are filled.

When the distance to the detected object reaches the close-in detection zone as set in the “Distance Alert Screen”, the yellow triangle will be replaced by a red stop sign and the volume will increase to the highest level as set in the “Volume Adjust Screen”.

Figure 17. Active Screen, Close Detection

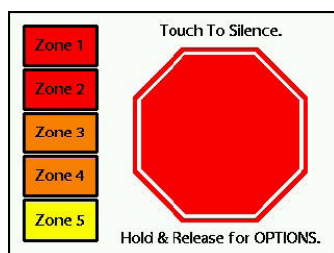

The audible warning can be silenced at any time by simply pressing anywhere on the screen. The audible will not become active again until the detection clears.

The Home screen can be reached while the Active screen is displayed by executing a long press on the screen. After pressing the screen for at least 1 second the message on the bottom of the screen will change from “Hold & Release for Options” to “Release”. Once the “Release” message pops up, release your finger from the screen and the Home screen will be displayed (Figure 2.1). Follow the procedure shown in “Configuring The Display” starting on page 2 to make any adjustments to the display. If nothing is pressed and the machine is still in reverse, the display will revert to the Active screen after 5 seconds. If you enter the Settings Menu and want the system to return to the active screen, simply press the  icon.



Connection to Sensor Failed Screen:

If installation method “A” (display wired to ignition and reverse) was used and the sensor does not communicate with the display when the machine is placed into reverse, the home screen will show a “Connection to Sensor Failed” (Figure 18) error. If installation method “B” (display wired only to ignition) was used and the sensor does not communicate with the display, the display will continue to show the “Not In Reverse” message (Figure 14) as it relies on the sensor to tell the display when reverse has been activated. In either case, if the machine is placed into reverse and the system does not become active see the Troubleshooting portion of this manual.

Figure 18. Home Screen, Connection to Sensor Failed!

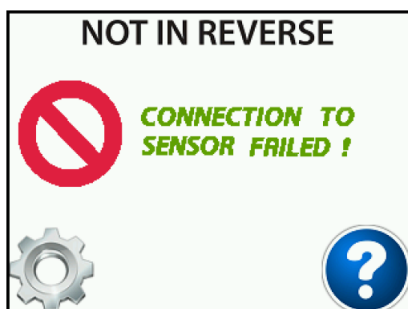
**Sensor BIST Failure Screen:**

If this screen appears, please contact Preco Electronics™ for assistance.

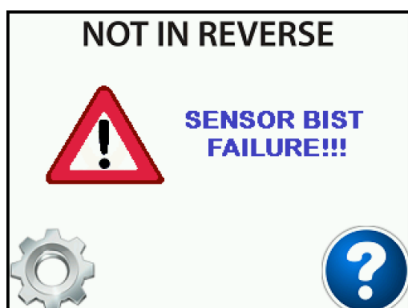

Figure 19. Home Screen, Sensor BIST Failure



Specifications

DISPLAY SPECIFICATIONS (Typical)

Housing Material:	CYCOLOY LG9000, TILO 1310 TPE
Dimensions:	3.36"H x 3.60"W x 1.34"D (8.5cm x 8.4cm x 3.4cm)
Weight:	0.27 lb. (0.12 kg)
Mounting:	User dependent, 1/4-20 thread

ELECTRICAL SPECIFICATIONS

Input Voltage:	9-33VDC, over voltage protected to 150V
Input current:	0.1 amp maximum, inrush current limited to 1A
Polarity:	Negative ground, Polarity protected to 150V
Power Connection:	Three 26 AWG wires, connect to ignition and/or reverse lamp circuit
Aux Output:	Single 26 AWG wire, +33V tolerant
	Active State: switched to ground, over current protected to 125mA sink maximum.
	Inactive State: high impedance

OPERATING CHARACTERISTICS

Detection Range:	User adjustable from 10 – 20FT (3-6M)
------------------	---------------------------------------

COMMUNICATION

Wireless	ZigBee 2.4GHz, IEEE 802.15.4 compliant DSSS baseband
Data Update Rate	125mS

REGULATORY COMPLIANCE

Compliant with FCC part 15.247
FCC ID: OXZWD7102

PIN	SIGNAL NAME	COLOR
1	CAN HIGH	RED
2	CAN LOW	GREEN
3	AUX OUT	BLACK
4	MACHINE REVERSE	BROWN
5	MACHINE GROUND	ORANGE
6	MACHINE POWER	YELLOW
7	SHIELD	SHIELD

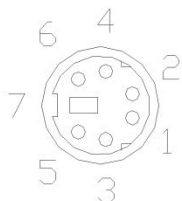

CONNECTOR FACE VIEW

PRODUCT MANUFACTURED IN THE USA



Troubleshooting

Display will not turn on:

- Verify that DC power (9-33V) is applied to the display.
- Verify that the display has a solid ground connection.

Display cannot find or connect to the wireless sensor:

- Verify that DC power (9-33V) is applied to the sensor.
- Sensor may be out of range. Contact Preco Electronics for assistance.

“Not In Reverse” message is present, but machine is in reverse:

- Verify display is configured properly, see page 6.
- For installation method A (see page 3), verify reverse connection has 9-33V present.
- For installation method B (see page 3), verify sensor is powered and communicating.

“Connection to Sensor Failed!” message is present:

- Verify display is configured properly, see page 6.
- Verify sensor is powered and communicating, see page 6.

“Sensor BIST Failure!” message is present:

- Contact Preco Electronics for assistance.

There is a constant detection even if there is no object in the machines vicinity:

- Check for any objects on the machine that the sensor may be detecting. Relocate the sensor so it does not see these objects.
- If the detection is showing up in Zone 4 or 5, the sensor may be detecting the ground. In an open field, either move the sensor up higher or slightly angle the sensor upward 5 to 10 degrees. The minimum recommended mounting height is 24 inches.



Additional Options

Custom System Configurations – Thanks to the advanced engineering by the Preco Engineers, the technology behind PreView Sensors can easily integrate or control your machines existing or new safety systems.



Warranty Information

MANUFACTURER STANDARD LIMITED WARRANTY AND LIMITATION OF LIABILITY

Manufacturer warrants that on the Date of Purchase this Product will conform to Manufacturer's published specifications for the product, which are available from Manufacturer on request, and Manufacturer warrants that the product is free from defects in materials and workmanship. This Limited Warranty extends for twelve (12) months from the date of shipment. Manufacturer will, at its option, repair or replace any product found by Manufacturer to be defective and subject to this Limited Warranty.

This Limited Warranty does not apply to parts or products that are misused; abused; modified; damaged by accident, fire or other hazard; improperly installed or operated; or not maintained in accordance with the maintenance procedures set forth in Manufacturer's Installation and Operating Instructions.

To obtain warranty service, you must ship the product(s) to the specified Manufacturer location within thirty (30) days from expiration of the warranty period. To obtain warranty service you must call Preco Customer Service at 866-977-7236 or 208-323-1000, or fax your request to 208-323-1034. Customer Service will issue warranty authorization and further instructions. You must prepay shipping charges and use the original shipping container or equivalent.

EXCLUSION OF OTHER WARRANTIES: MANUFACTURER MAKES NO OTHER WARRANTIES, EXPRESSED, IMPLIED OR STATUTORY. THE IMPLIED WARRANTIES FOR MERCHANTABILITY OR FITNESS FOR A PARTICULAR PURPOSE ARE HEREBY EXCLUDED AND SHALL NOT APPLY TO THE PRODUCT. BUYER'S SOLE AND EXCLUSIVE REMEDY IN CONTRACT, TORT OR UNDER ANY OTHER THEORY AGAINST MANUFACTURER RESPECTING THE PRODUCT AND ITS USE SHALL BE THE REPLACEMENT OR REPAIR OF THE PRODUCT AS DESCRIBED ABOVE.

LIMITATION OF LIABILITY: IN THE EVENT OF LIABILITY FOR DAMAGES ARISING OUT OF THIS LIMITED WARRANTY OR ANY OTHER CLAIM RELATED TO MANUFACTURER'S PRODUCTS, MANUFACTURER'S LIABILITY FOR DAMAGES SHALL BE LIMITED TO THE AMOUNT PAID FOR THE PRODUCT AT THE TIME OF ORIGINAL PURCHASE. IN NO EVENT SHALL MANUFACTURER BE LIABLE FOR LOST PROFITS, THE COST OF SUBSTITUTE EQUIPMENT OR LABOR, PROPERTY DAMAGE, OR OTHER SPECIAL, CONSEQUENTIAL OR INCIDENTAL DAMAGES BASED UPON ANY CLAIM FOR BREACH OF CONTRACT, NEGLIGENCE OR OTHER CLAIM, EVEN IF MANUFACTURER OR A MANUFACTURER'S REPRESENTATIVE HAS BEEN ADVISED OF THE POSSIBILITY OF SUCH DAMAGES.

Manufacturer shall have no further obligation or liability with respect to the product or its sale, operation and use, and Manufacturer neither assumes nor authorizes the assumption of any other obligation or liability in connection with such product.

This Limited Warranty gives you specific legal rights, and you may also have other legal rights which vary from state to state. Some states do not allow the exclusion or limitation of incidental or consequential damages, so the above exclusion or limitation may not apply to you.

Any oral statements or representations about the product which may have been made by salesmen or Manufacturer representatives do not constitute warranties. This Limited Warranty may not be amended, modified or enlarged, except by a written agreement signed by an authorized official of Manufacturer which expressly refers to this Limited Warranty.



